

بِسْمِ اللَّهِ الرَّحْمَنِ الرَّحِيمِ

Seismic Method

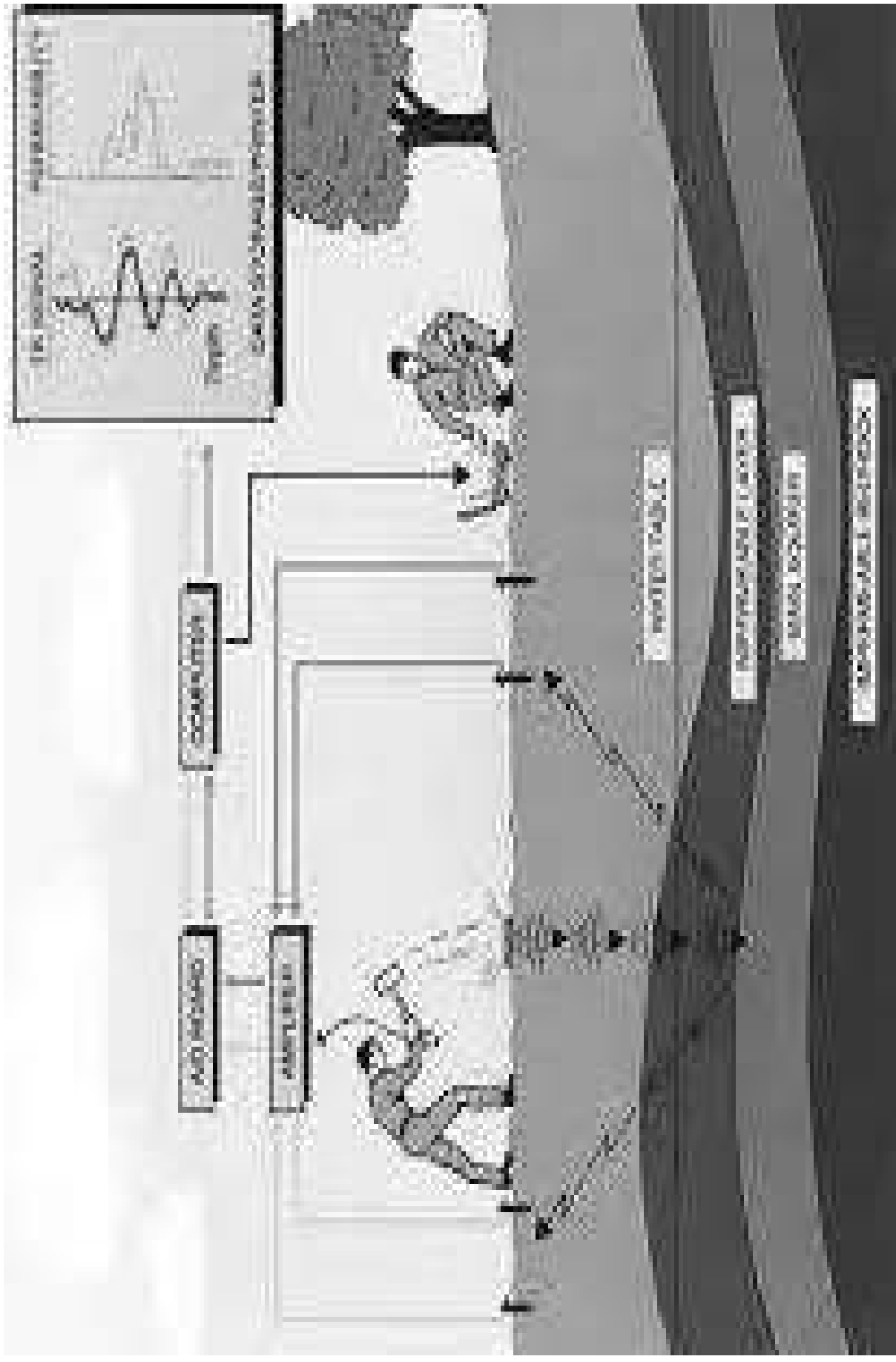

Geophysics?

- Apply the principles of physics to the study of the Earth
- Investigation of the interior of the Earth involves taking measurements at or near the Earth's surface that are influenced by the internal distribution of physical properties. The analysis of these measurements reveals information on the Earth's interior

This could be the discovery of the century. Depending, of course, on how far down it goes...

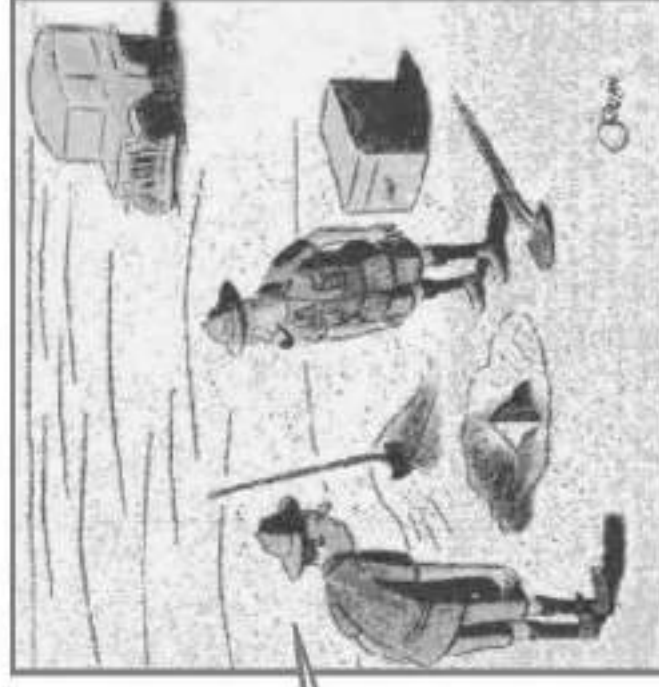

Geology + Physics = Geophysics

a) Geology

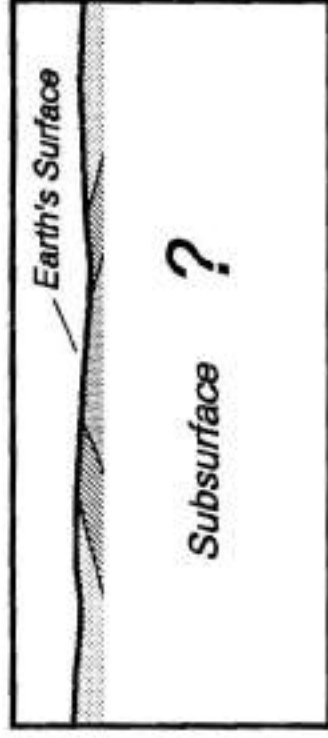

b) Physics

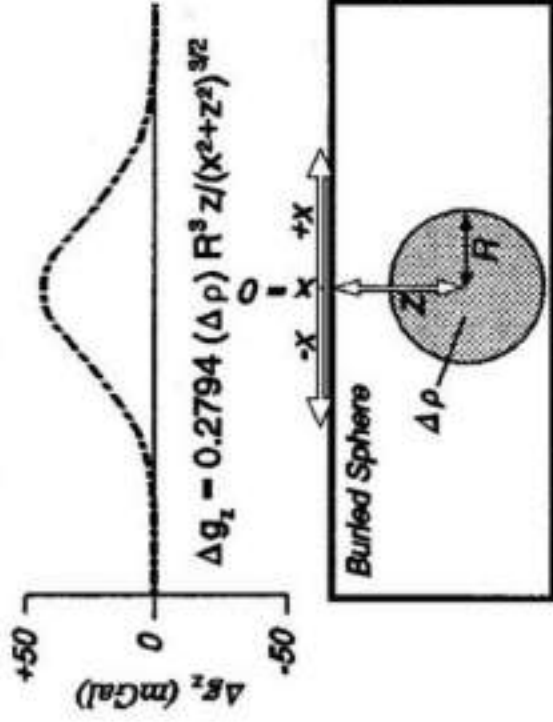

c) Predicted Anomaly after Adjusting Model

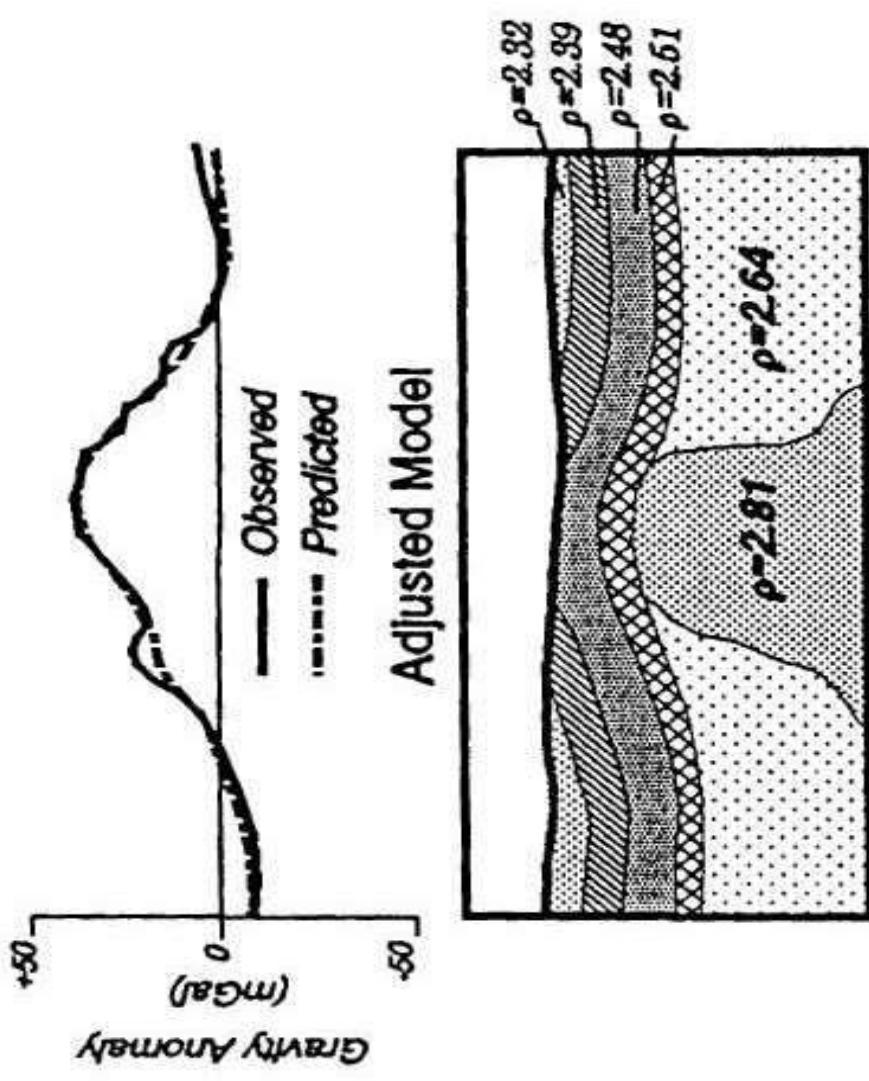

Geophysicists :- *Are scientists who study the structure and composition of the Earth.* They use sophisticated instruments to measure physical properties such as:

- Density,
- Electrical resistivity, electrical fields and radioactivity of rocks
- Velocity of sound waves transmitted through the ground
- Changes in gravity and magnetic fields of the Earth
- Reflection of radio signals from rocks near the Earth's surface.



3D seismic survey

Geophysicists use one or more of these measurements to find:-

- oil
- natural gas
- potash, coal, iron, copper
- and many other minerals

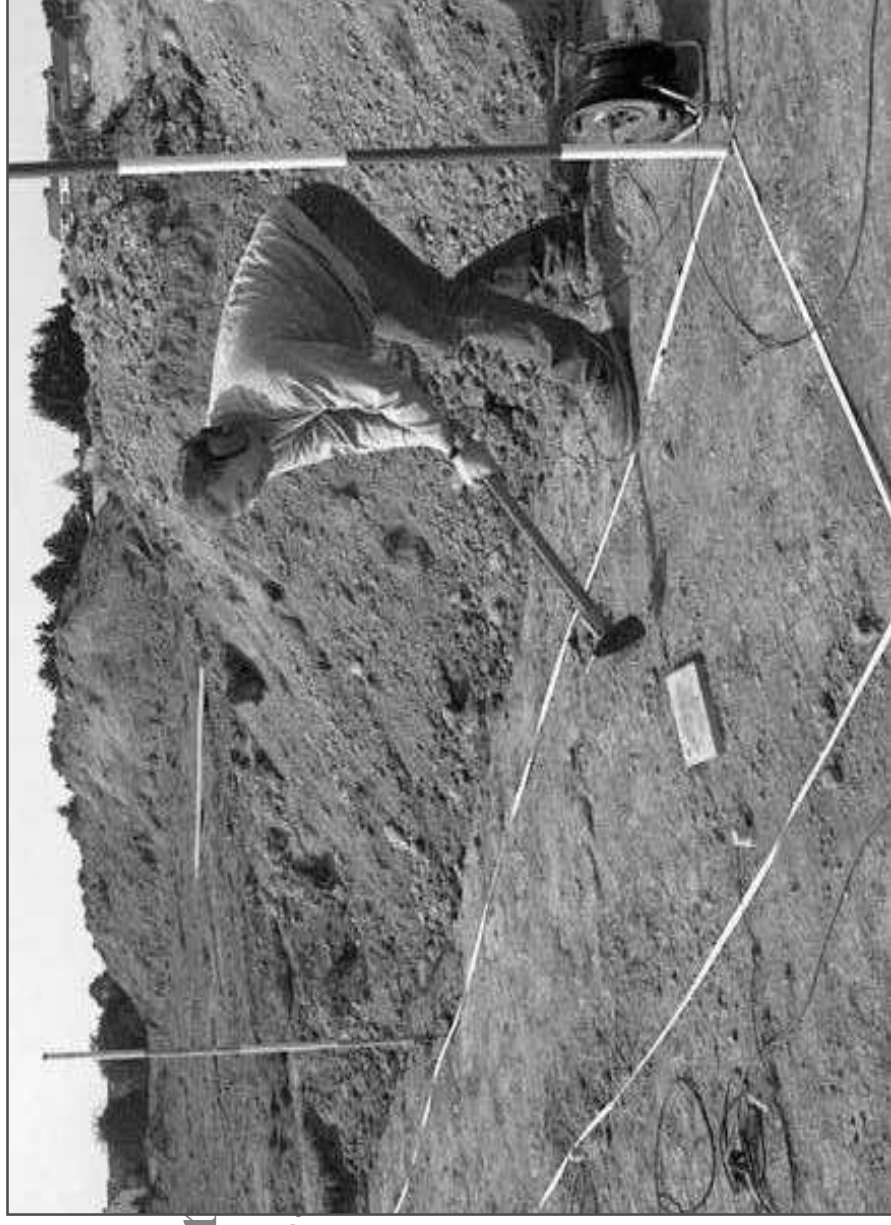

In addition, the properties are used to identify environmental hazards and evaluate areas for dams or building construction sites

Geophysical measurements:
tool to obtain an image of the subsurface

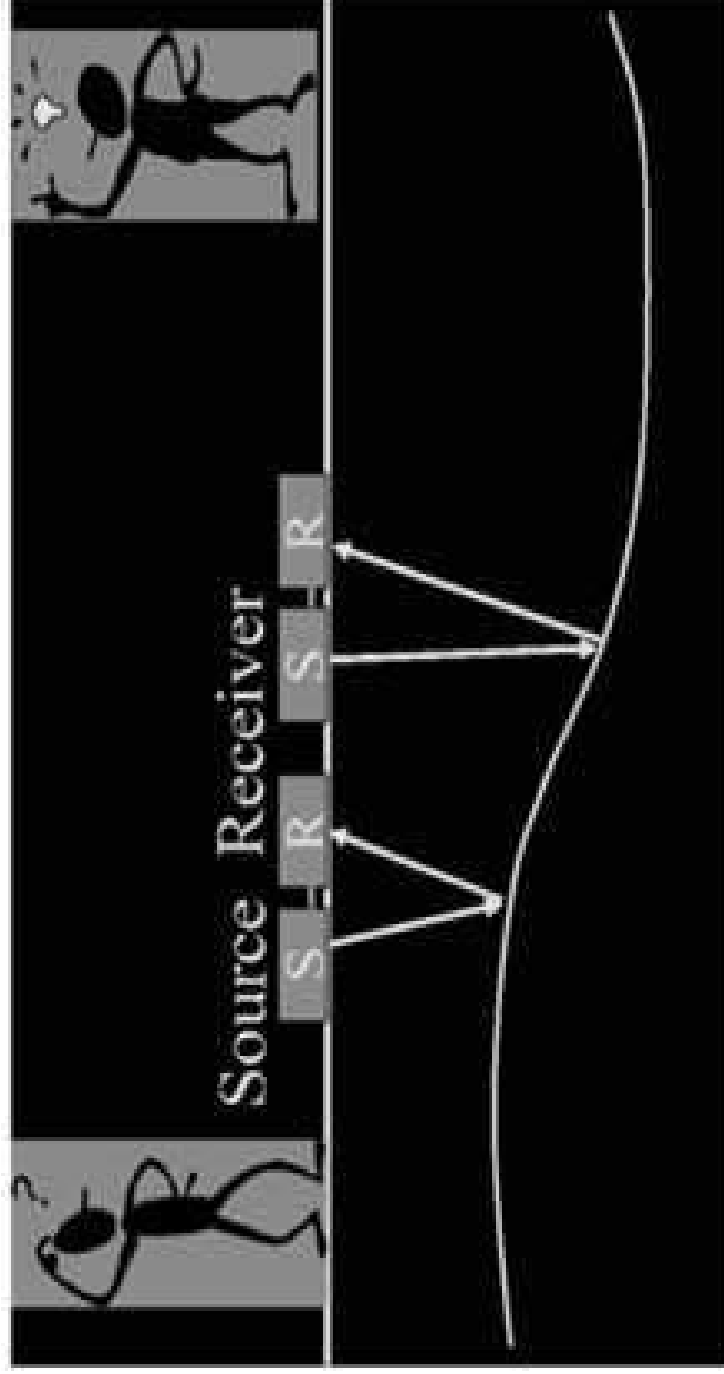

Measurement → Processing → Image

- .. Mapping of geological structures
- .. Detect objects

SYLLABUS OF THE SEISMIC METHOD

- Introduction
- Theoretical background
- Elastic parameters
- Seismic Waves
- Propagation of the seismic waves
- Seismic velocity
- Geometry of reflected wave path
- Geometry of refracted wave path
- Instruments
- Data Corrections
- Data Processing
- Interpretation of the seismic data

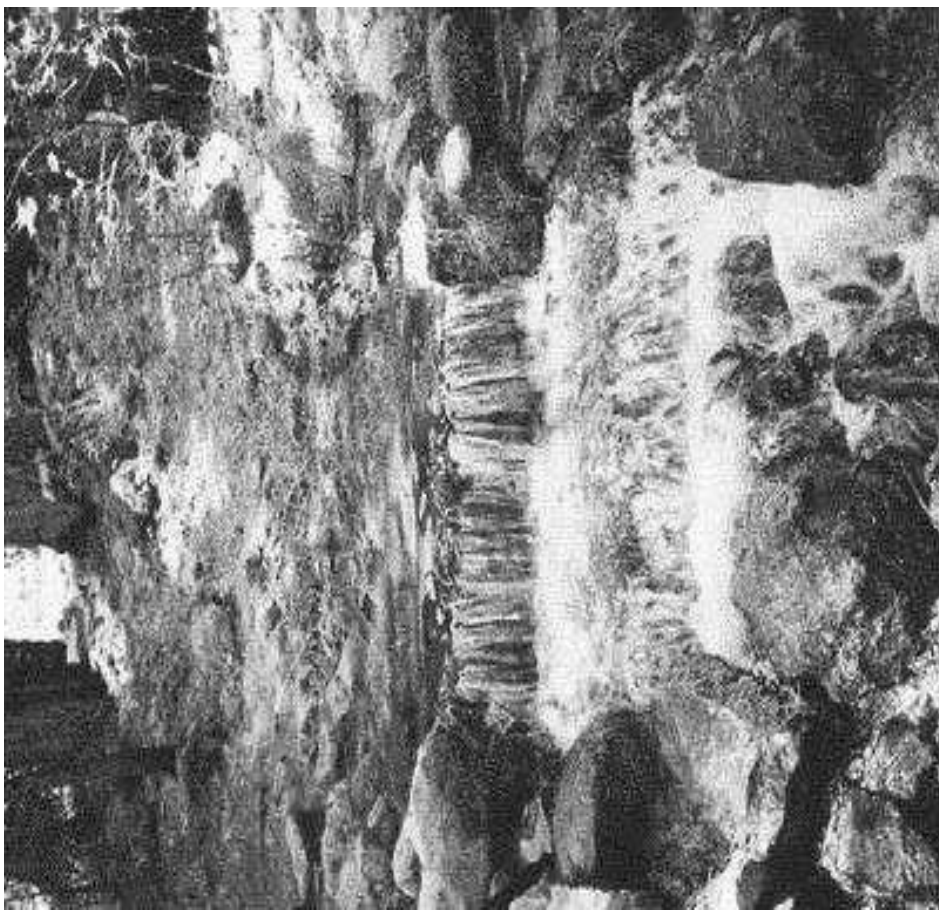

References:-

1. Applied Geophysics, 1996, Telford, W., M.
2. An introduction to applied and environmental geophysics, 1997, Reynolds, J. M.
3. Introduction to geophysical prospecting, 1988, Durbin, M. B.
4. Applied and environmental geophysics, 1999, Sharma, V.P.
5. An Introduction to geophysical Exploration, 2002, 3rd edition, Philip Keary, Meachael Brookes and Ian Hill, Blackwell Science, Oxford 257 p
6. www.Geophysics.Com
7. www.Geophysics.net

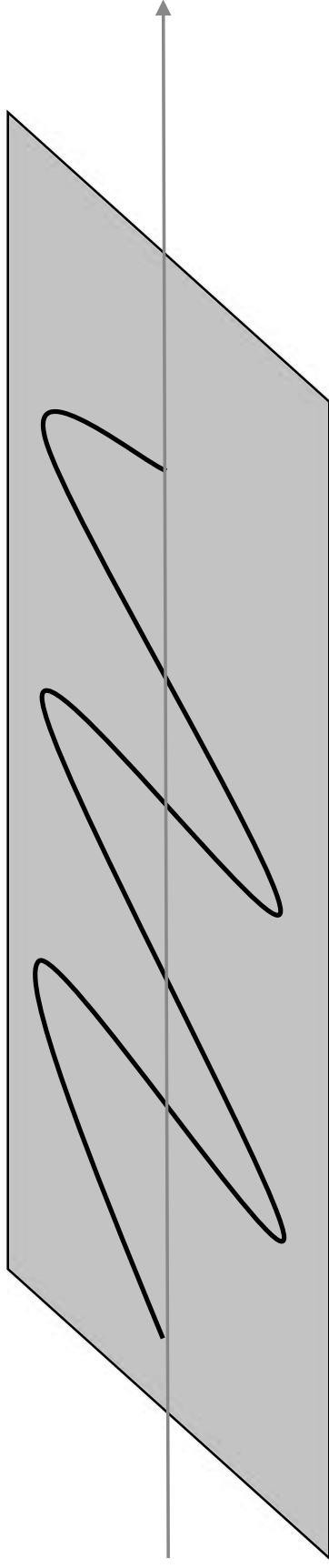

Introduction

The *seismic method* is by far the most important geophysical technique in term of expenditures and number of geophysicists involved.

The predominance of the method over other geophysical methods is due to various factors, the most important of which are the:-

-- **High accuracy**

-- **High resolution and penetration...** of which the method is capable.

.... Of the all geophysical methods, the seismic method is the most **direct and** the **least ambiguous** results.

The seismic method of exploration or prospecting exploit (**يستخدم**) the fact that the velocity of elastic waves is different in different rocks.

In seismic surveying, **seismic waves** are created by a controlled source and propagate through the subsurface. Some waves will return to the surface after refraction or reflection at geological boundaries within the subsurface. Instruments distributed along the surface detect the ground motion caused by these returning waves and hence measure the arrival times of the waves at different ranges from the source (next figure).

These travel times may be converted into depth values and, hence, the distribution of subsurface geological interfaces may be systematically mapped.

The basic techniques of the seismic method

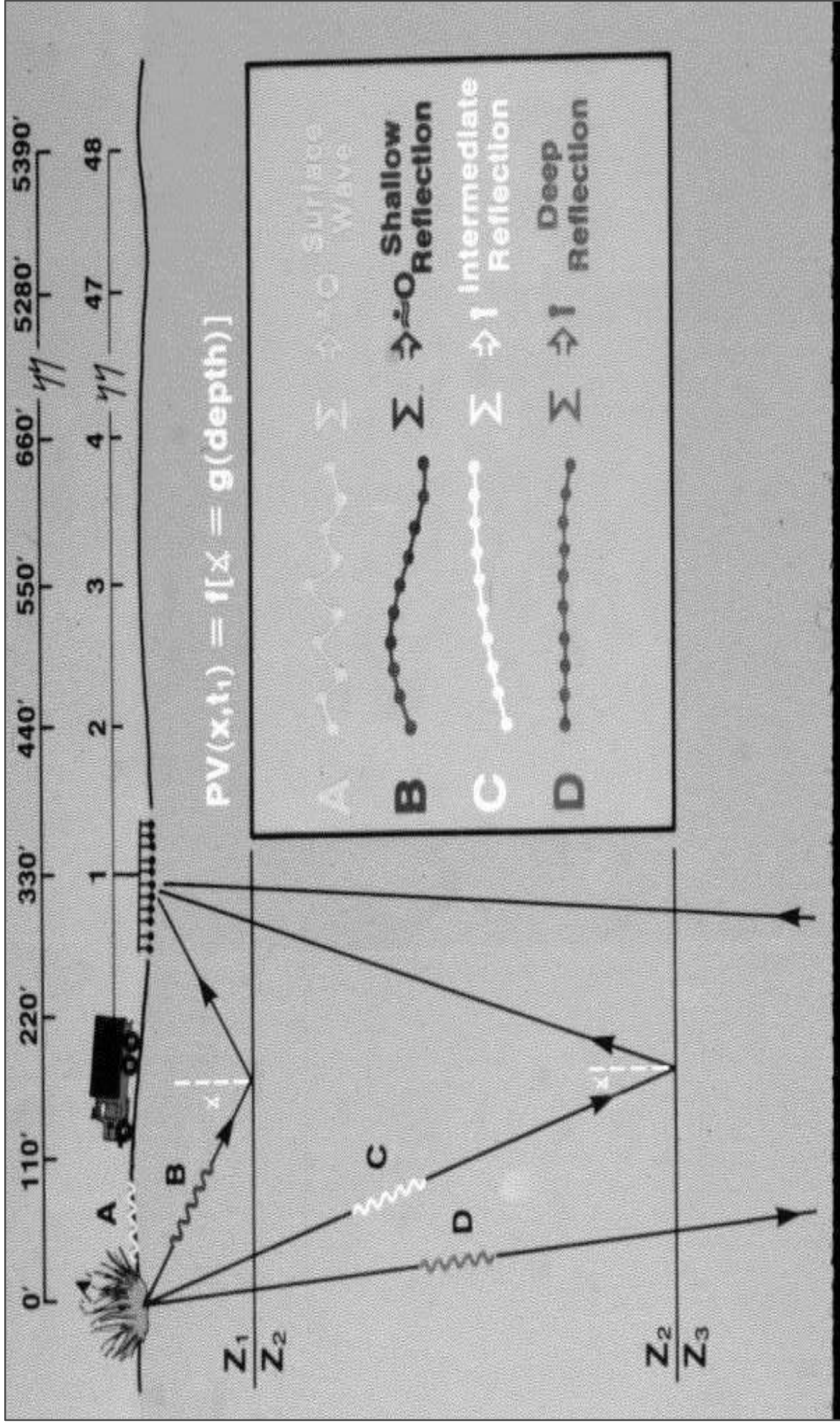

The standard method of producing seismic waves (energy injection) is to:-

- ... Explode a dynamite charge in hole. Other technique such as
- ... Weight dropping and
- ... Electrodynamics shaking have been also used.

The main characteristic features of seismic prospecting methods are:-

- I. Introduction of an **artificial waves** and its instance of occurrence are known precisely.
- II. Very sensitive **instruments are used to detect and record** the resulting vibration.
- III. Very **accurate timing devices** are used, since the length of seismic record in oil prospecting, for example, seldom exceeds four to five seconds. The events must be measured to the nearest two to three millisecond .
(msec = 10^{-3} sec.).

..... **Seismic surveying** can be carried out on **land** or at **sea**.

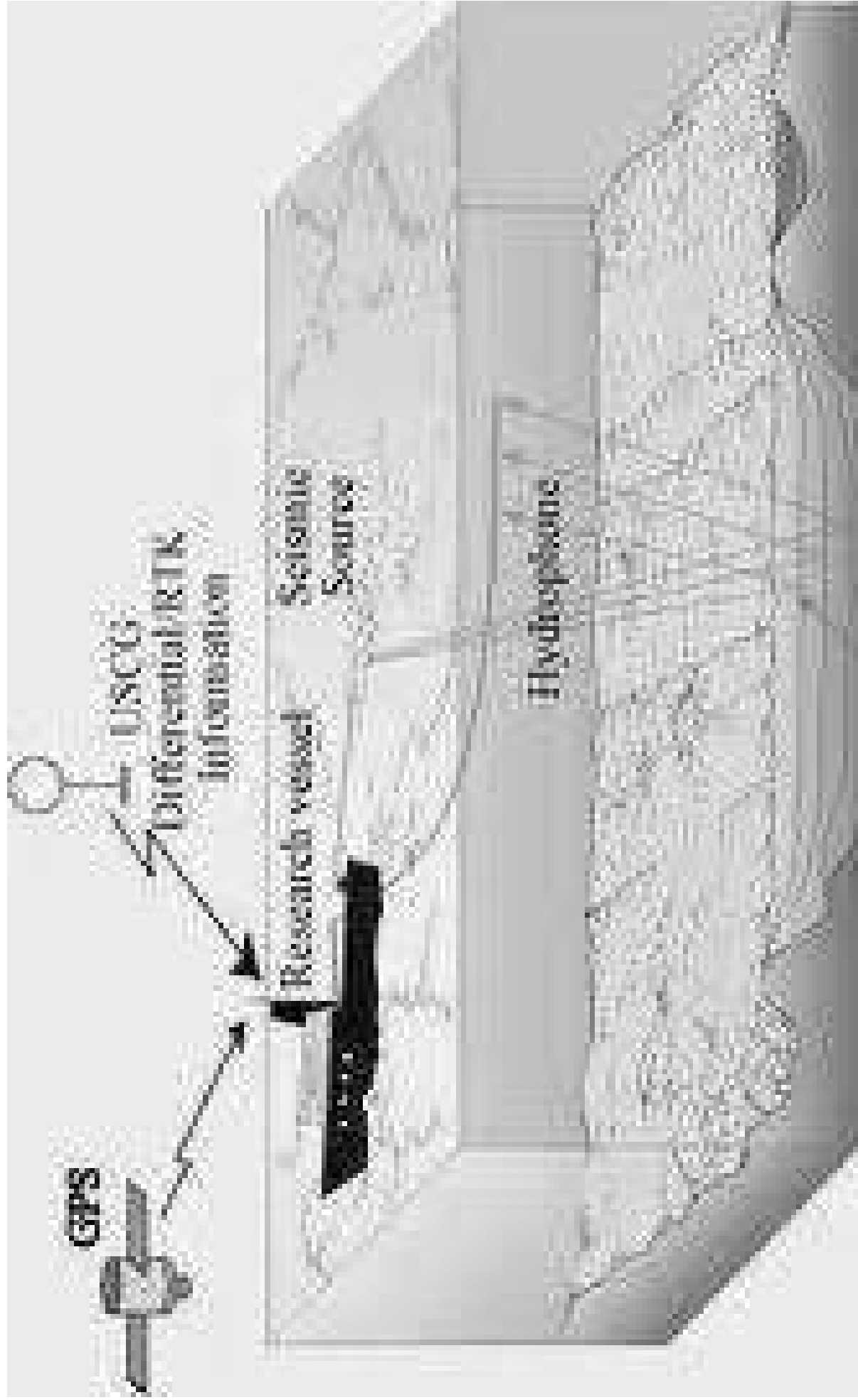

SEISMIC REFLECTION
(Subsurface Coverage)

Applications

Seismic methods are widely applied to **exploration problems** involving the **detection and mapping** of subsurface boundaries of, normally, simple geometry. They also identify significant physical properties of each subsurface unit.

--- The methods are particularly well suited to the mapping of layered sedimentary sequences and are therefore widely used in the search for **oil and gas**.

The methods are also used, on a smaller scale:-

- For mapping of near-surface sediment layers,
- For location of the water table ,
- In an engineering context,
- In site investigation of foundation conditions including the determination of depth to bedrock.
- Detection of subsurface cavities.
- Crustal structure and tectonics.

Stress and strain

When external forces are applied to a body, balanced internal forces are set up within it.

Stress is defined as a (**force per unit area**) is a measure of the intensity of these balanced internal forces.

The stress of any surface within the body may be resolved into a component of **normal stress** perpendicular to the surface and a component of **shearing stress** tangentially in the plane of the surface.

strain :- A body subjected to stress undergoes a change of **shape** and / or **size** .

Up to a certain limiting value of stress, known as the *yield strength* of a material, *the strain is directly proportional to the applied stress* (**Hooke's Law**).

This (**elastic strain**) is reversible so that removal of stress leads to a removal of strain. If the yield strength is exceeded the strain becomes non-linear and partly irreversible (i.e. permanent strain results), and this is known as (**plastic or ductile**). If the stress is increased still further the body fails by (**fracture**).

A typical stress–strain curve is illustrated in the next figure:-

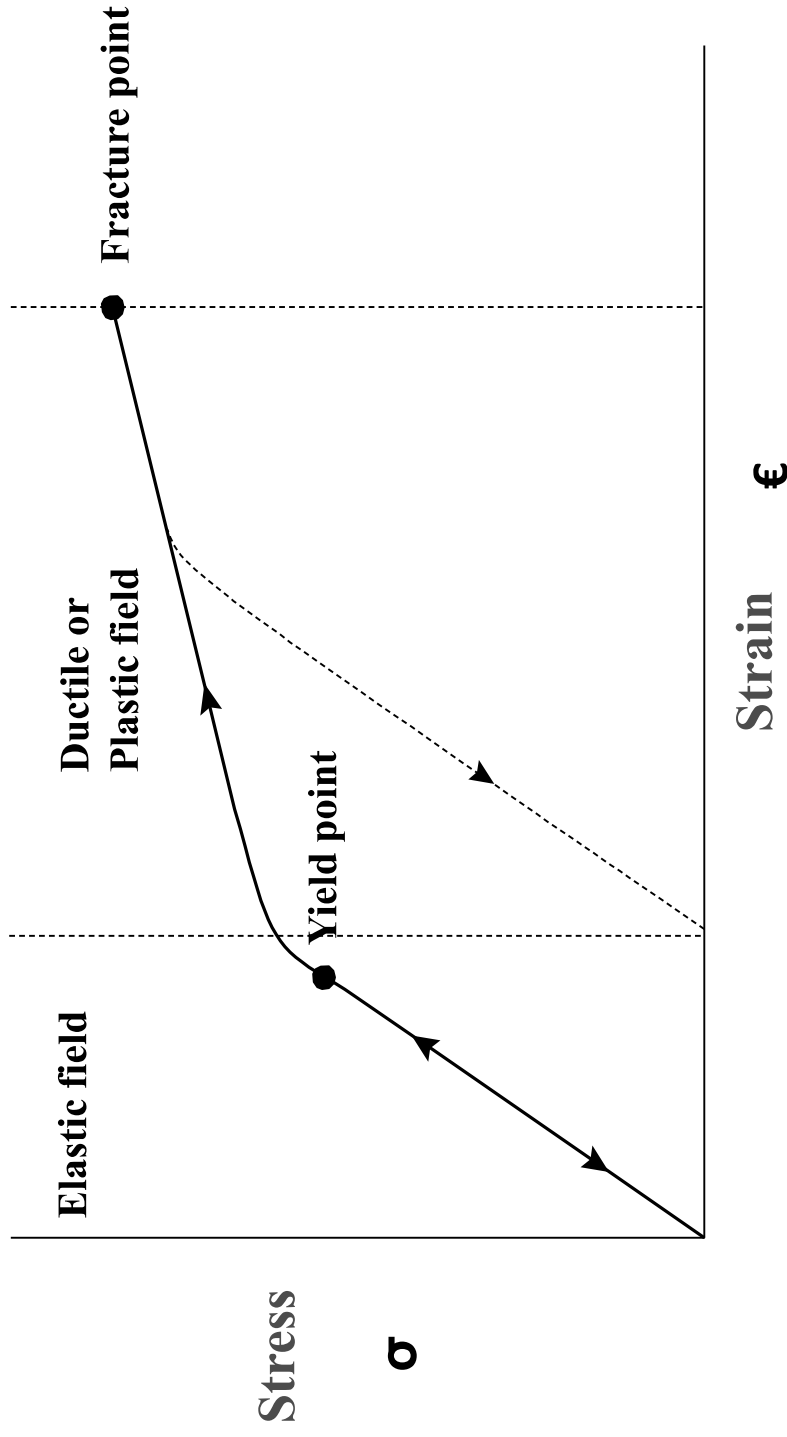

The linear relationship between stress and strain in the elastic field is specified for any material by its various *elastic moduli*, each of which expresses the ratio of a particular type of stress to the resultant strain.

Theory of Elasticity

I. The fundamental physical property mainly utilized in seismic method is **the elastic wave transmission through the solid Earth**. The basis of the method is the theory of elasticity, which is governed by **Hooke's Law**

Stress \propto strain

$$\sigma \propto \epsilon$$

$$\sigma = C \epsilon$$

Where C = elastic modulus (معامل), σ = stress, and ϵ = strain

II. The **elastic property** of the medium through which elastic waves are of the medium as a given by this reaction

$$veolocity = \sqrt{\text{elastic modulus/density}}$$

$$v = \sqrt{\frac{C}{\rho}}$$

III. The elastic properties of the medium may be described by a number of elastic constants. These constants are related to each other if the medium is assumed to be isotropic and homogeneous.

The elastic moduli (معاملات) are: (a) Young's modulus E . (b) Bulk modulus K .
 (c) Shear (rigidity) modulus (μ). (d) Axial modulus and (e) Poisson's ratio (σ)

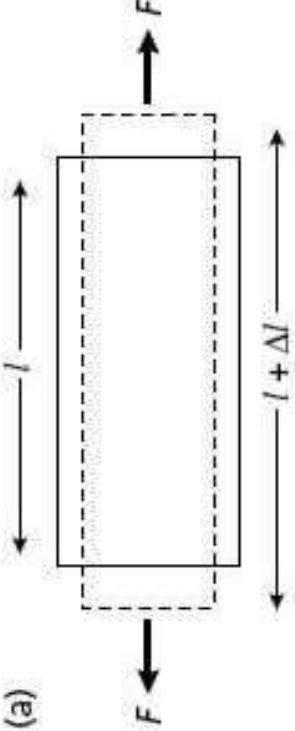
(a) 

$$E = \frac{\text{longitudinal stress } F/A}{\text{longitudinal strain } \Delta l/l}$$

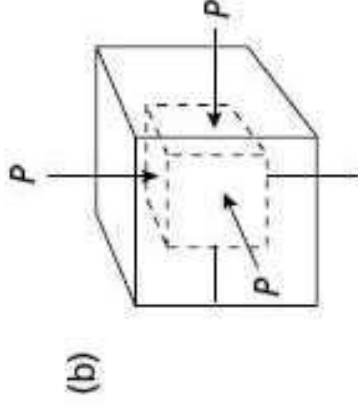
(b) 

$$K = \frac{\text{volume stress } P}{\text{volume strain } \Delta V/V}$$

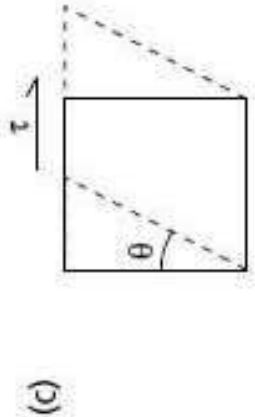
(c) 

$$\mu = \frac{\text{shear stress } \tau}{\text{shear strain } \tan \theta}$$

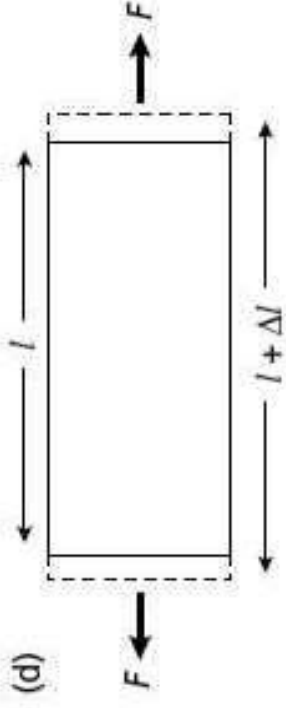
(d) 

$$\psi = \frac{\text{longitudinal stress } F/A}{\text{longitudinal strain } \Delta l/l}$$

(no lateral strain)

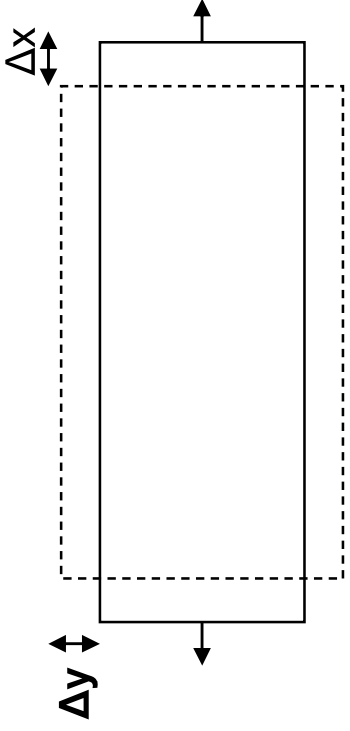
(e) 

$$\sigma = (\Delta y/y) / (\Delta x/x)$$

= Contraction / Extension

The elastic moduli are related to each other as follows:-

$$K = \frac{E}{3(1-2\sigma)}$$

(Bulk modulus معامل)

$$\mu = \frac{E}{2(1+\sigma)}$$

(Shear (rigidity) modulus)

$$\lambda = \frac{\sigma E}{(1+\sigma)(1-2\sigma)}$$

(Lamy constant)

$$E = \mu \frac{(3\lambda+2\mu)}{(\lambda+\mu)}$$

(Young's modulus)

$$\sigma = \frac{\lambda}{2(\lambda+\mu)}$$

(Poisson's ratio)

Field procedure

The **seismic crew** or **party** consists mainly of a

- Party chief computer,
- ... Observers, geologists
- ... Surveyors,
- ... Drillers,
- ...Shooters and other persons, **depending** on the:-
- . Objective of the party.
- . Type of instruments.
- . Terrain .
- . Area to be covered.

The essential instrumental requirements are to:-

- 1- generate a seismic pulse with a suitable source.
- 2- detect the seismic waves in the ground with a suitable transducer.(محول طاقة)
- 3- record and display seismic wave forms on a suitable seismograph.



When the area of the investigation has been decided upon:-

The first step :- Is to prepare a base map of the area.

The second step:- In a seismic survey is

- To select locations for shot holes.
 - The depth of holes
 - The weight of dynamite for the shot (a few grams to several kilograms)
- are important factors controlling the quantity of seismogram record.

The third step... Followed by



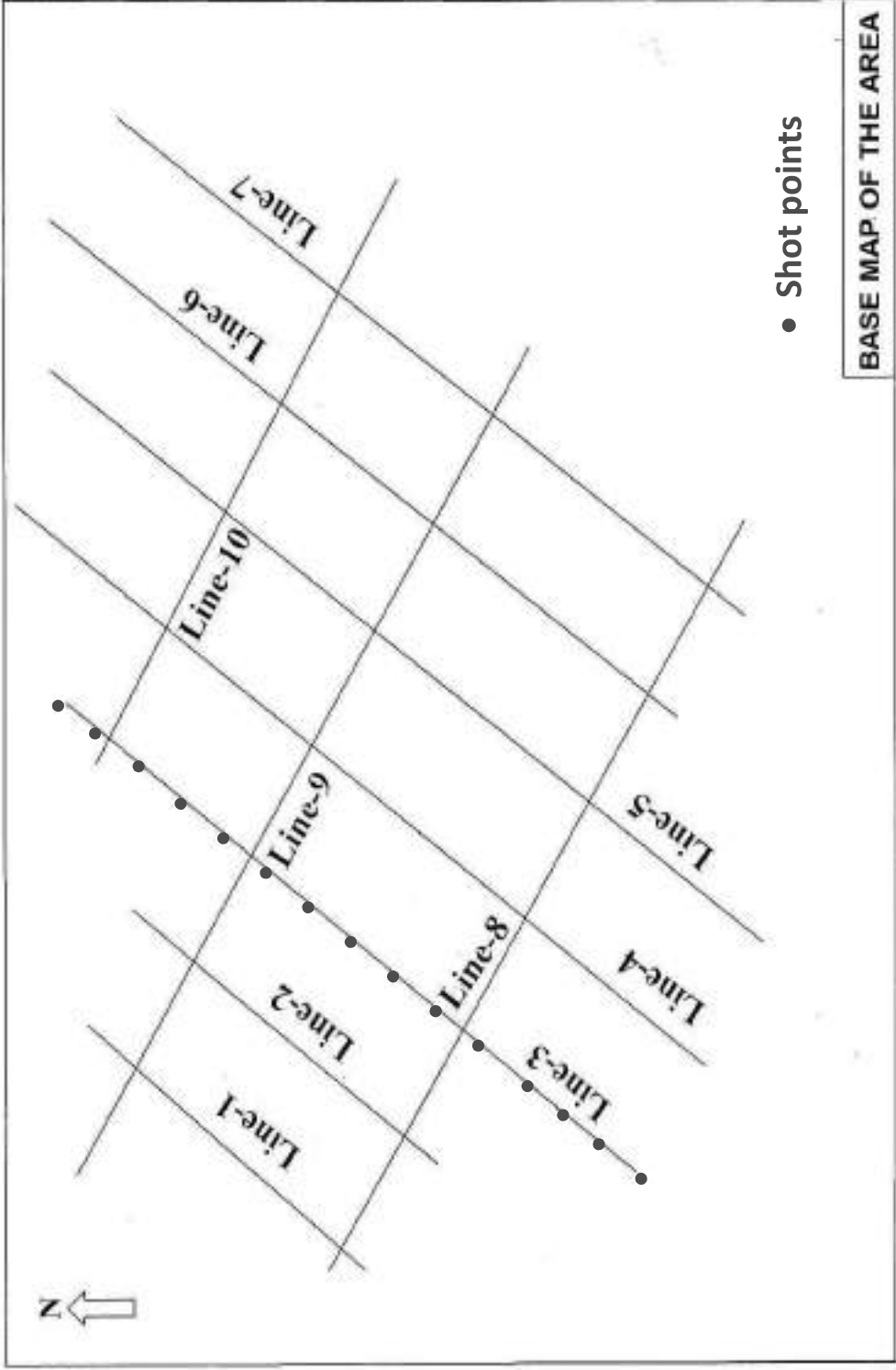

• Shot points

BASE MAP OF THE AREA

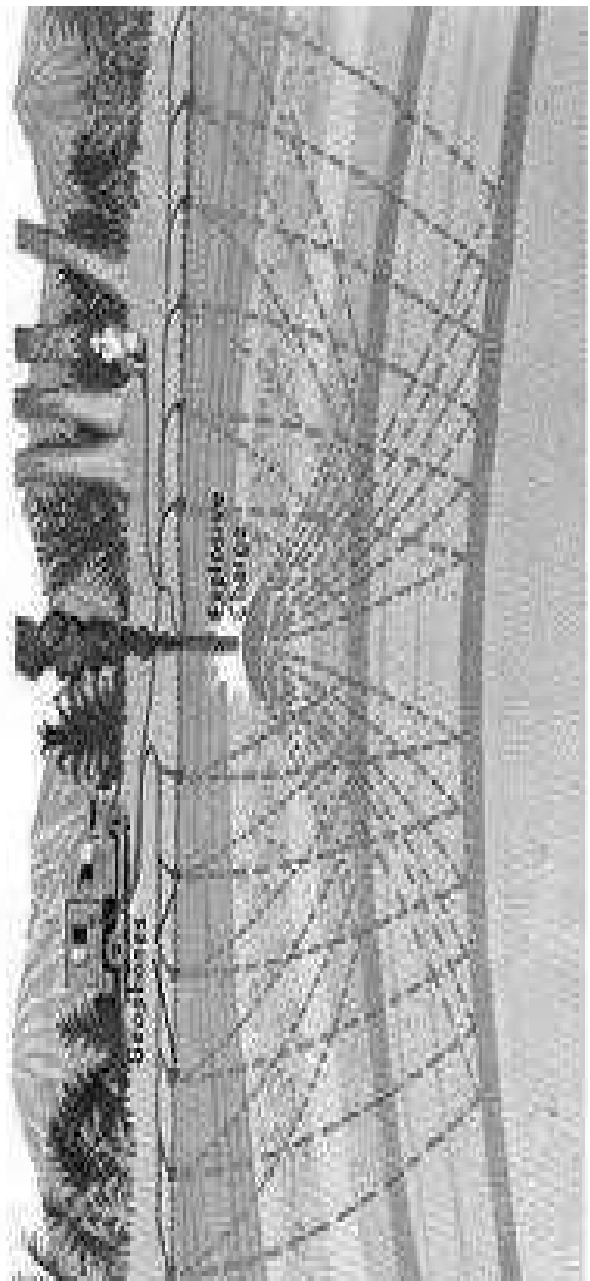
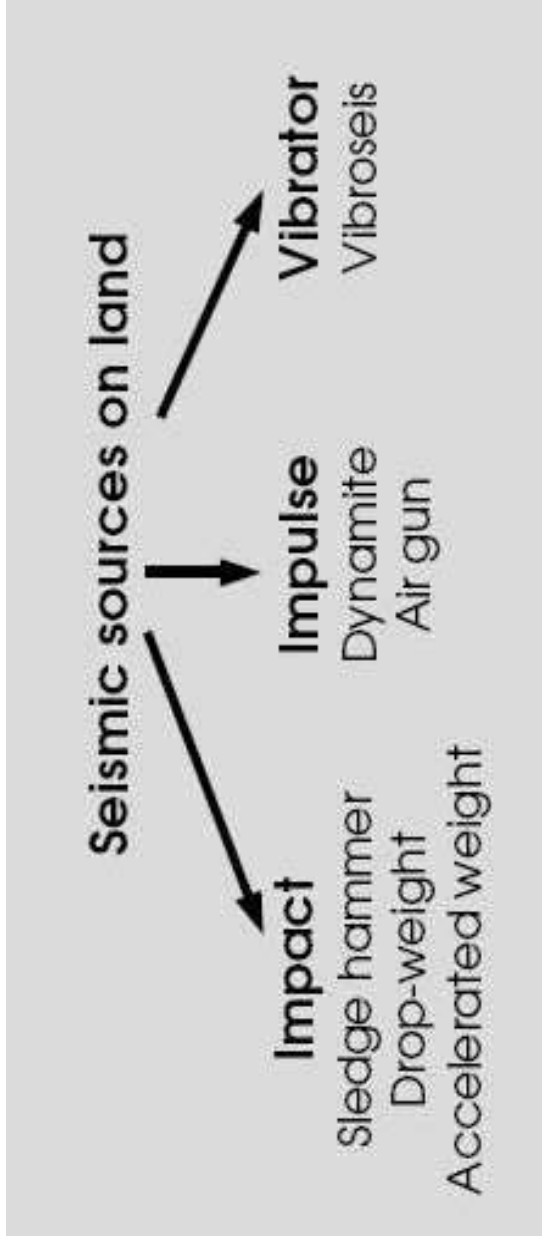



The third step:-

-- Is to distribute the geophones firmly (بحزم) on the ground which may sometimes entail burying them below the surface.

..As a rule seismic wave registration are not taken with individual geophone, but with a number of coupled geophones called **geophone group**.

-- In most of the work the geophones are placed along a straight line (called a **profile**) through the point on the surface vertically above the shot . The procedure is known as **profile shooting**.

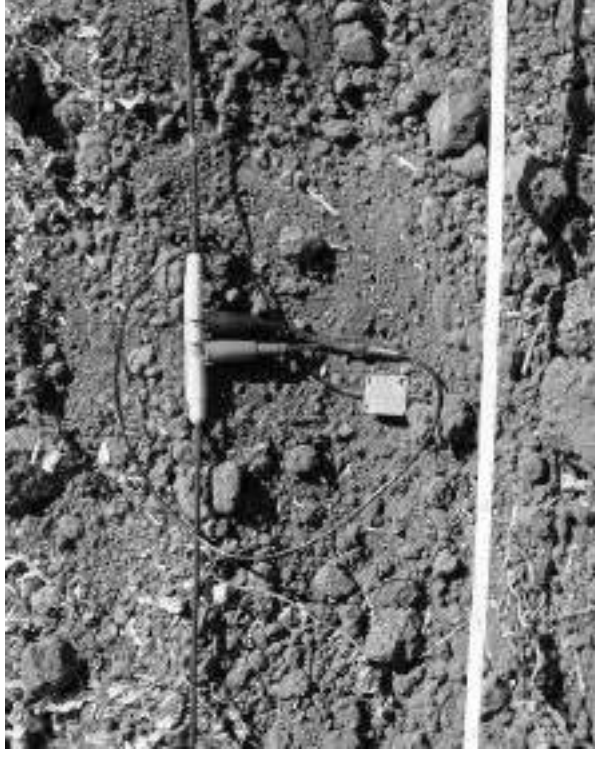

-- Others are used and the main purpose of using different arrangements is to **improve** the registration of primary reflections and to cancel out the disturbance or **noise** which may be defined as unwanted signal.

(Improve signal / noise ratio)

-- The geophones are connected to the **recording equipment** by long cables, the **amplifier** gains and **filters** are appropriately set and when the recording film is set in motion the shot is fired

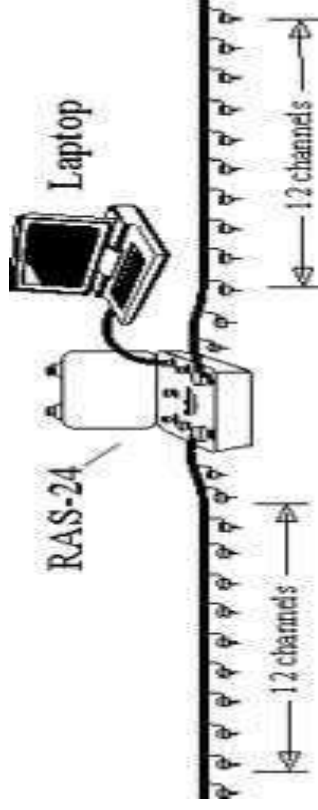

Geophones

Conversion of the ground motion to an electrical signal requires a transducer which is sensitive to some component of the ground motion, and can record the required range of frequencies and amplitudes without distortion. Geophones are of several designs, but the most common is the **moving-coil geophone**.

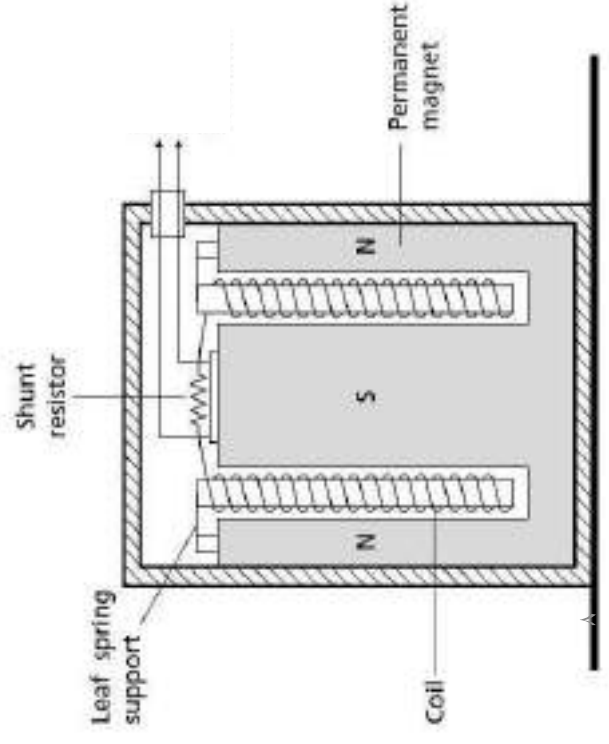
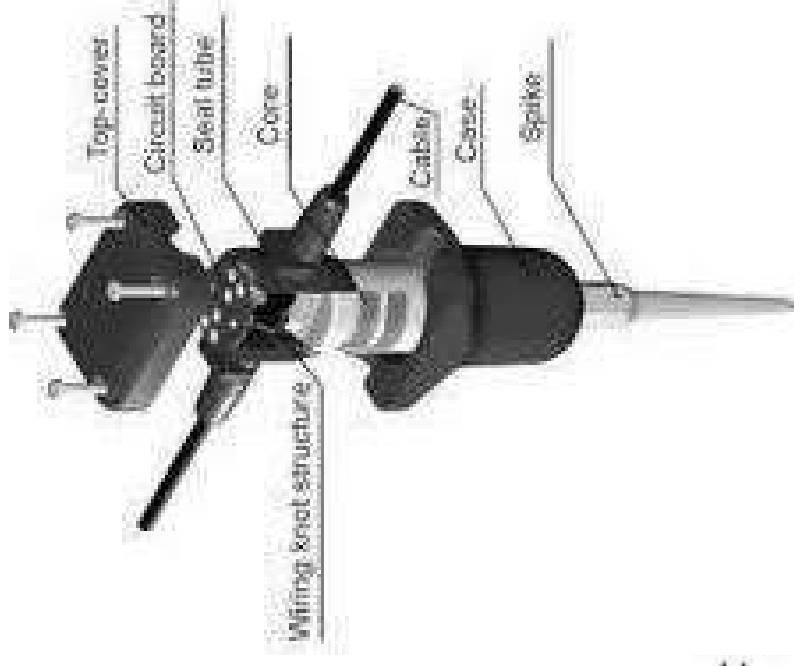

Seismic recording systems (seismograms)

1. The recording system must be timed accurately relative to the seismic source.
2. Seismograms must be recorded with multiple transducers simultaneously, so that the speed and direction of travel of seismic waves can be interpreted.
3. The electrical signals must be stored for future use.

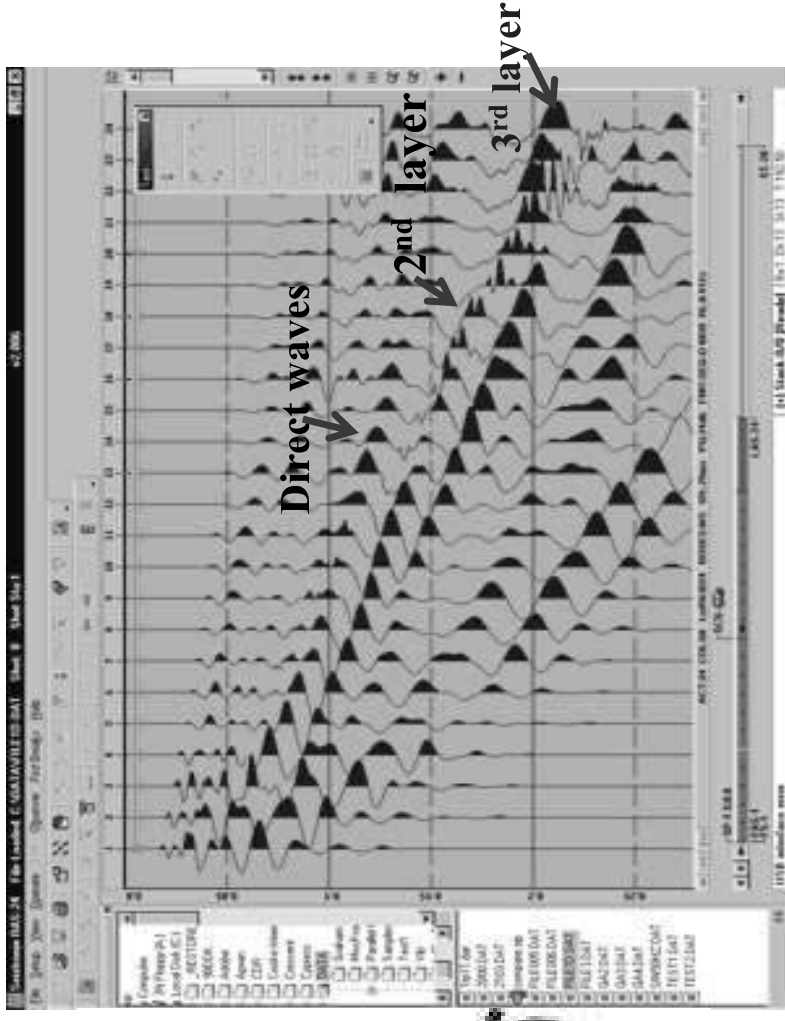

The basic techniques of the seismic method

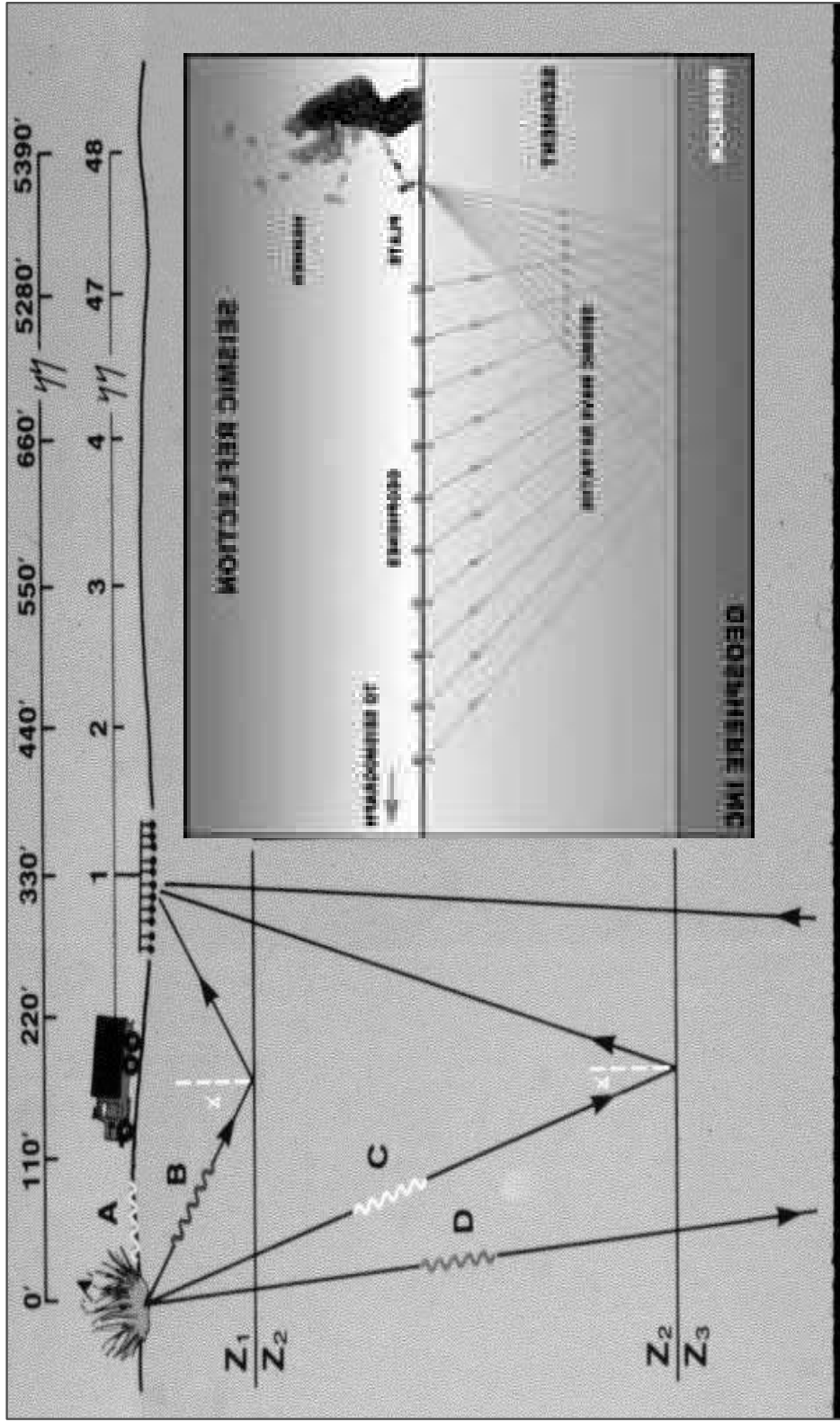

Sea survey

Hydrophone : It is a pressure geophone has piezoelectric (کهرابی ضغطی) property transform pressure to electrical voltage. Usually mounted on a large cable towed to seismic ship at depth 10 to 20 m below sea level.



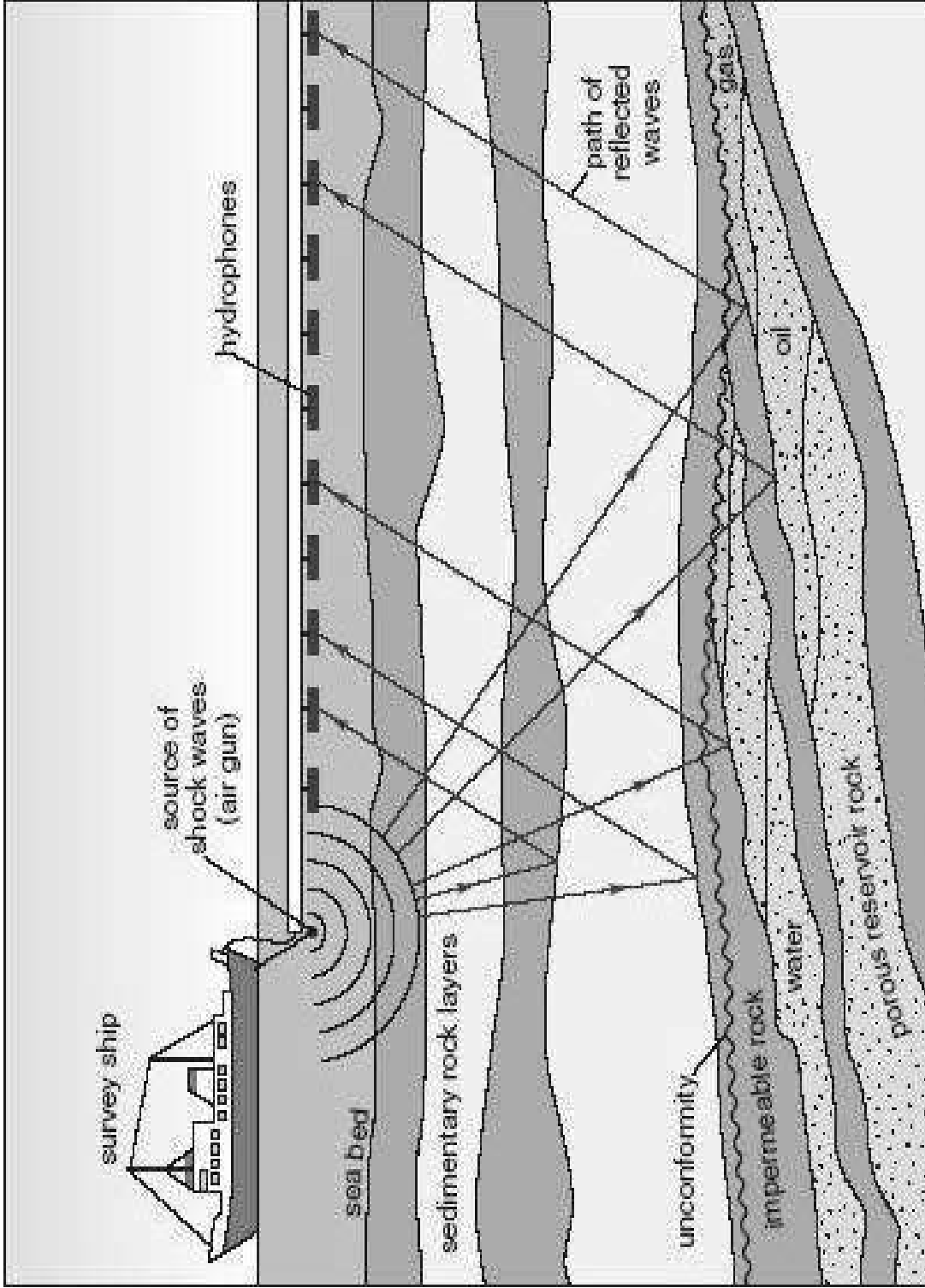

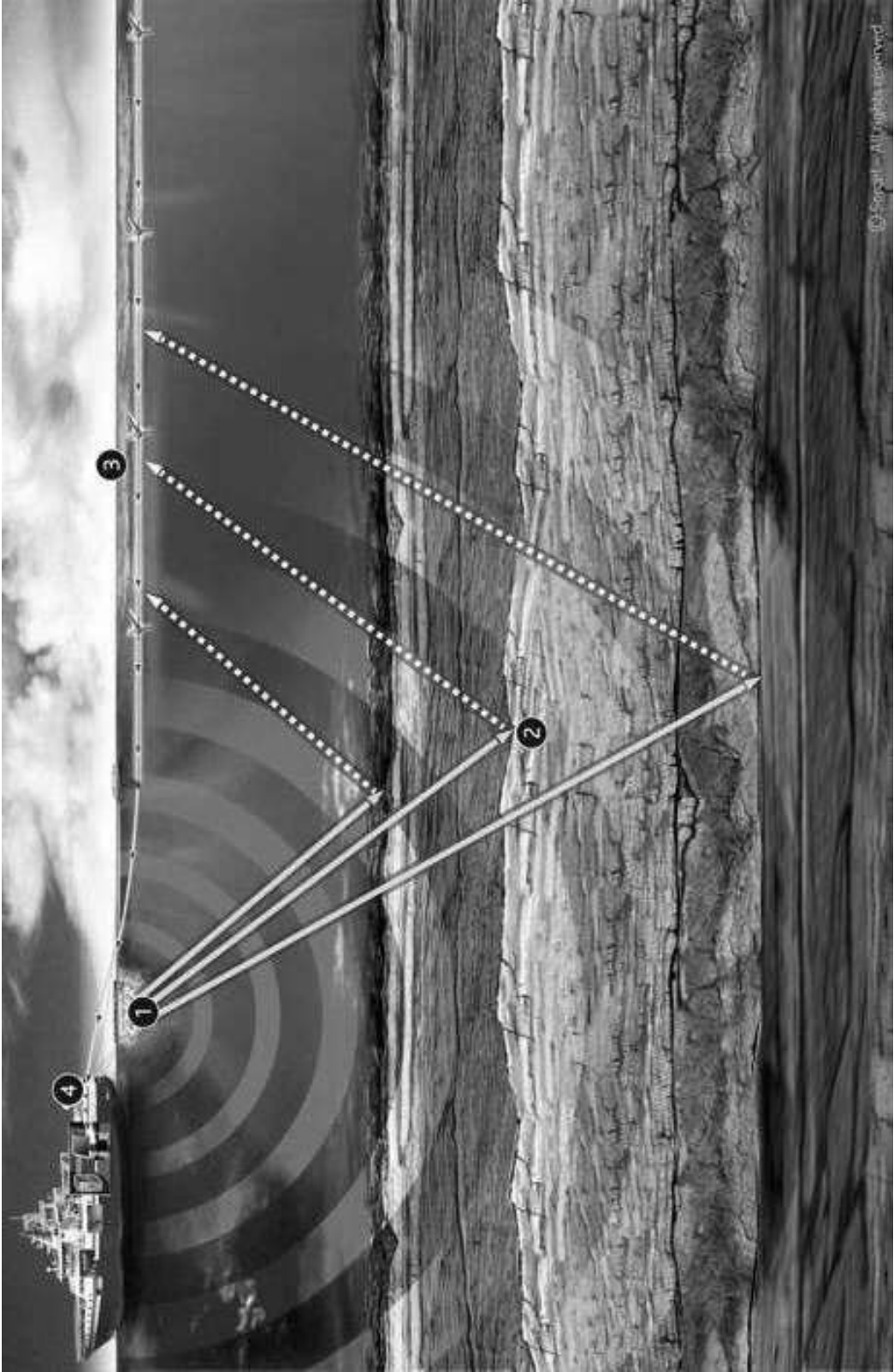

Spread Configuration: It means the relative position of the shot point to the geophone.

1- Split Spread: (SP) is placed at the center of spread.

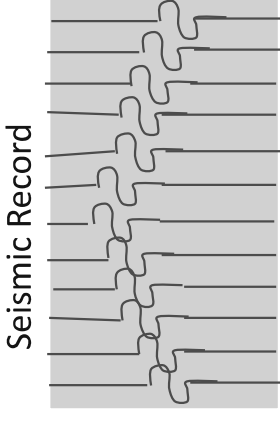

2- Split Spread with a gap: (SP) is placed at the center of spread with plotting a gap.

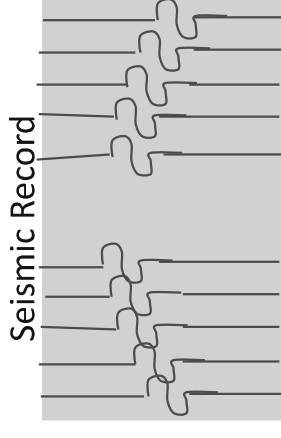

3- End of Spread: (SP) is placed at the end of spread.

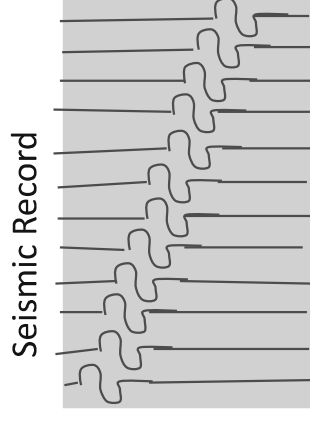

4- End of Spread with a gap: (SP) is placed at the end of spread with plotting a gap.

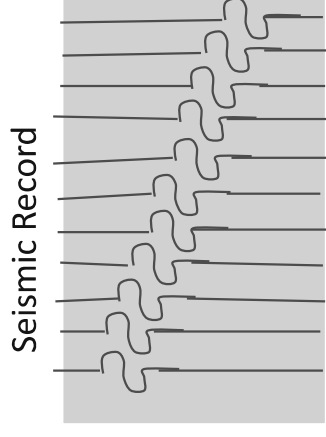

5- Unbalanced Spread : (SP) is not placed at the center

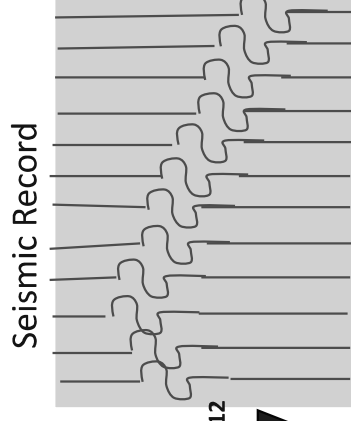

Seismic method involves (Refraction & Reflection)

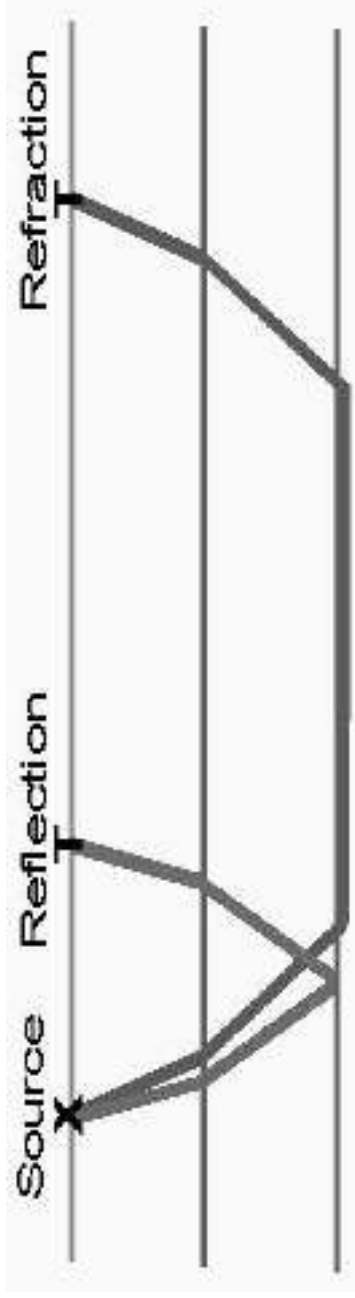

Seismic Reflection:

- ... The seismic signal is reflected back to the surface at layer interfaces, and is recorded at distances less than depth of investigation.
- ... It involves usually 2 or 3 cycles, and are often rich in frequency components (20-25 Hz).
- ... The shape of the alignment will be hyperbola.

Seismic Refraction:

- ... The signal returns to the surface by refraction at subsurface interfaces, and is recorded at distances much greater than depth of investigation.
- ... It involves many cycles and relatively low frequencies.
- ... The shape of the alignment will be straight.

Reflection & Refraction

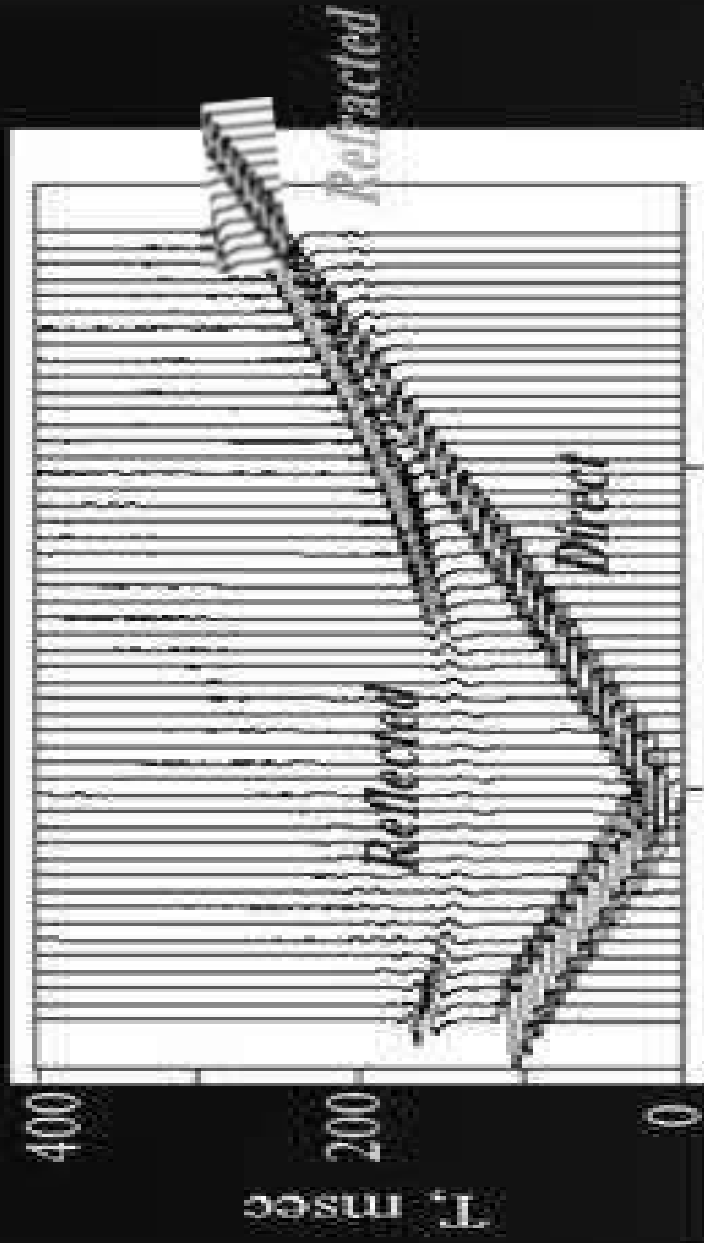

Seismic Refraction

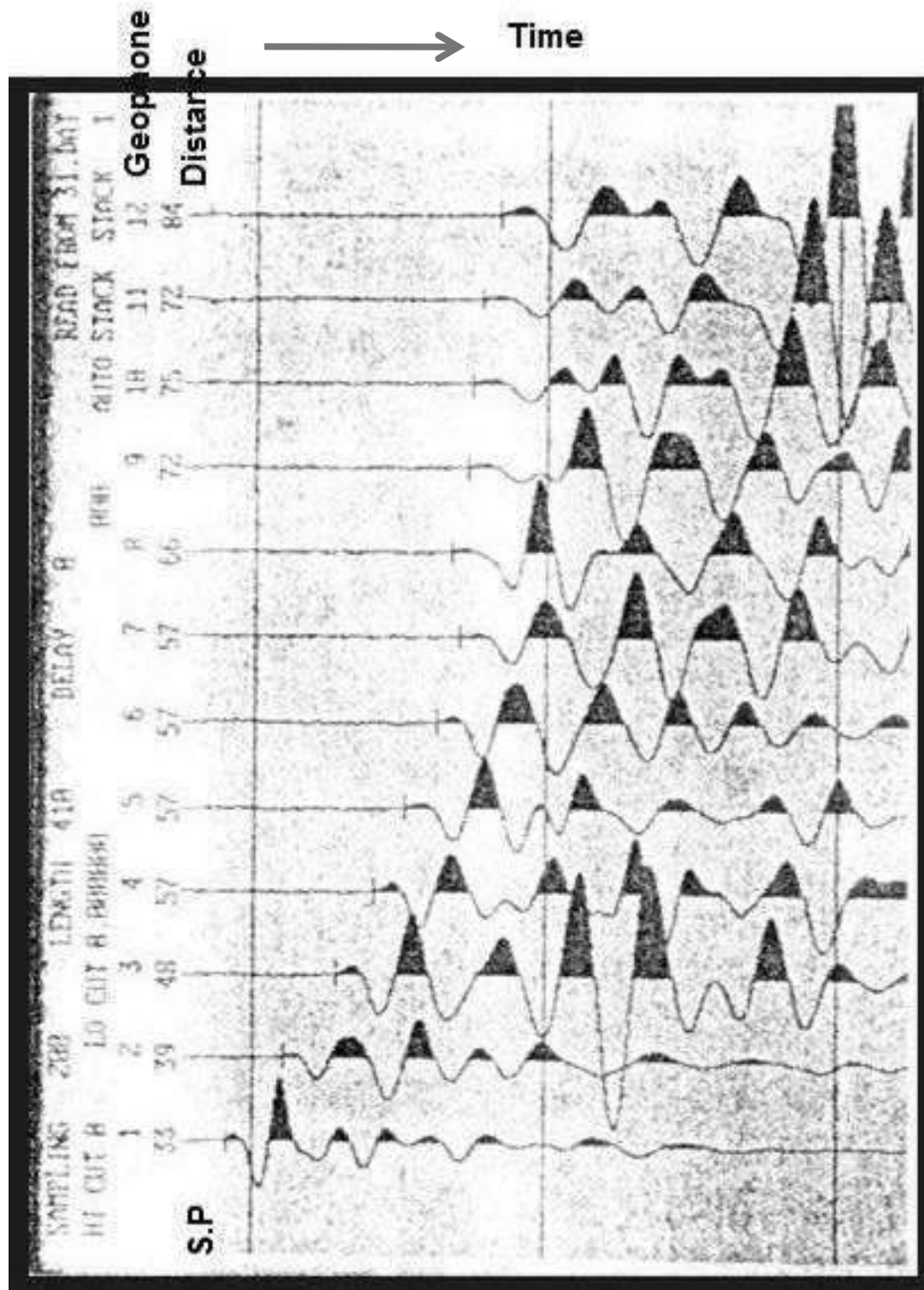

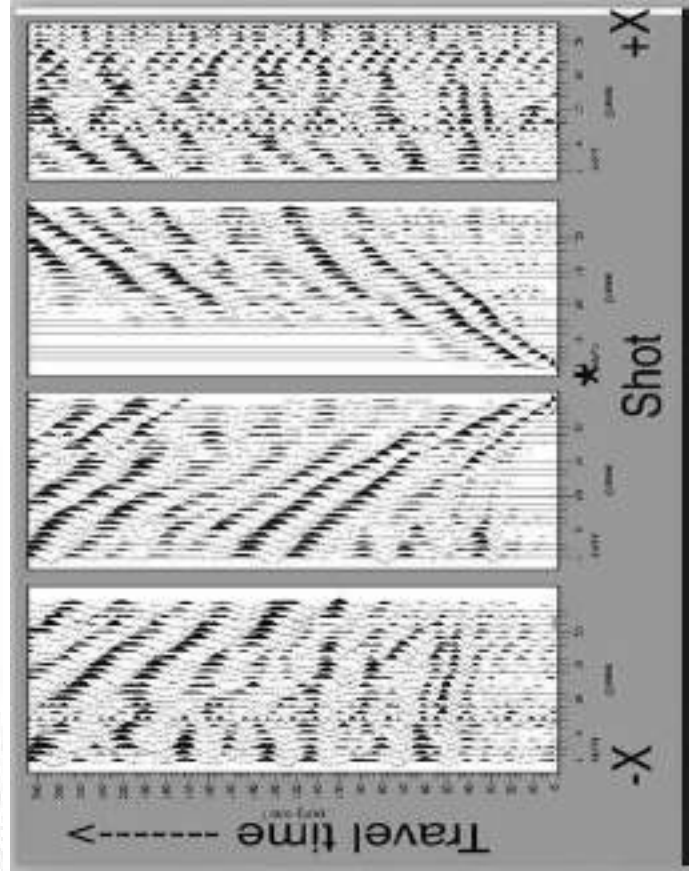
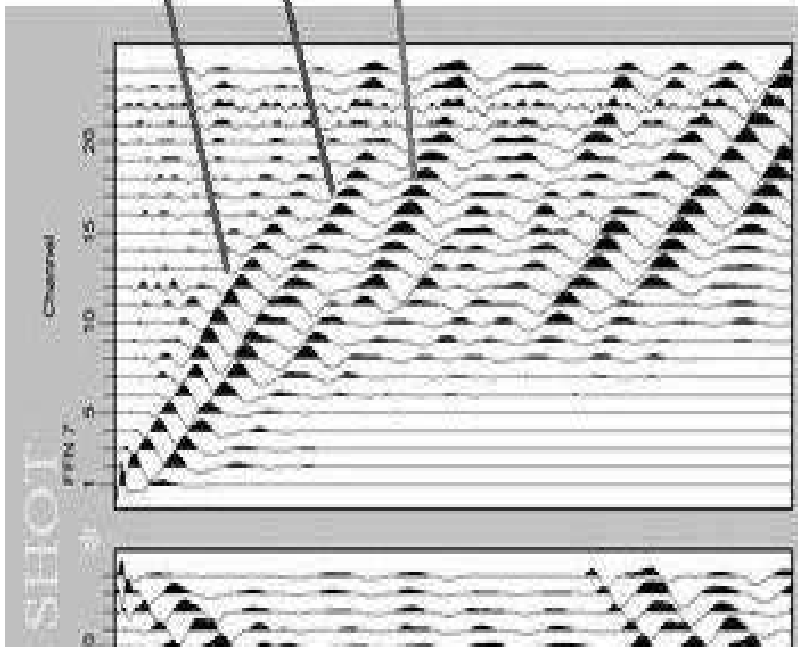

Refraction Seismic Method

- **The refraction method** was the earliest to be used as a seismic prospecting. It is valuable for reconnaissance surveys and where the high speed marker bed is overlain by lower speed formations ($V_2 > V_1$).
- **Refraction survey** yields data on :-
 -**seismic velocity of the various layers** as well as on their
 -**geometry** and makes it possible to
 -**identify formations** which are mapped
- **Refraction phenomena** occurs across any velocity interface in accordance with (Snell's Law). It employs waves that have passed down into the Earth, have been **critically refracted** at an interface and after travelling through the layer under the interface have been refracted out to the surface again. The angles of incidence and emergence at a marker bed are **critical angles**.

.... **Refracted waves** from successively deeper and faster marker beds appear as first arrivals with increasing offset . Refracted waves are called **head waves**.

.... **Refractor (or marker bed)** is a layer of high velocity than the overlying layers through which a head wave travels nearly parallel to its surface.

... **The quantity** observed in refraction method is the **time** between the explosion of the charge and the first disturbance recorded by the recording device (geophones), which are located at measurable distances from the source (shot point) in different lay- outs. The wave causing the disturbance , and these recorded by the geophone, is that which has travelled the minimum time (first arrivals).

--- **In refraction method** we usually construct the (**Time-Distance curve**) or travel time curve. The slopes of the segments of the curve give the reciprocals of the velocities for various refractor beds. It is necessary for the seismic velocity to increase with depth if the refraction method is to hold; and fortunately, this is the case in nature with few exceptions; since density increases with depth faster the elastic moduli does.

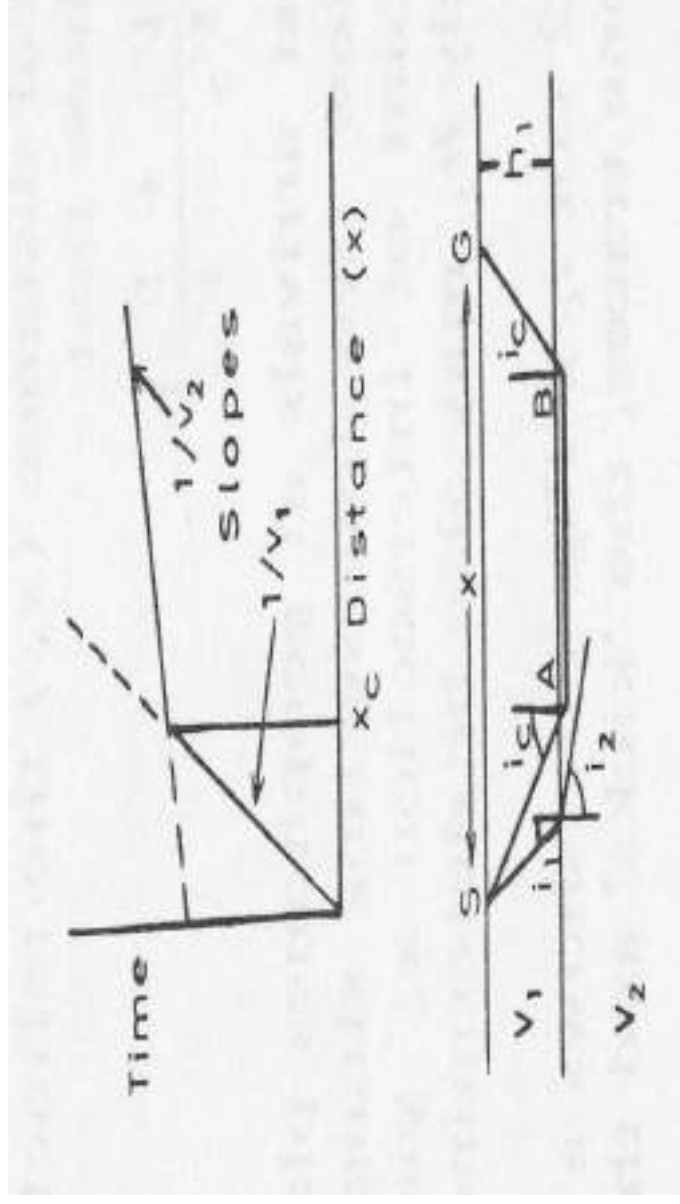

Seismic reflection surveying

Seismic reflection technique:-

- ... It is the most extensively used geophysical technique.
- ... The survey is a program to map geologic structures employing measurements of arrival times of reflected energy from interfaces where there is a **contrast in the acoustic impedance (velocity and density)**.
- ... It gives more direct and detailed picture of the subsurface geological structures.
- ... *Depths to interfaces are mapped very accurately.*
- ... **The method** is used exclusively for **petroleum prospecting**; it is more suitable in areas where the oil is in structural traps.
- ... It is also used useful for locating and detailing certain types of stratigraphic features.

The seismic reflection method:- is an accurate method; although more expensive but gives a more direct and detailed picture of subsurface geological structures than any other geophysical methods. The method is sometimes preceded by gravity , magnetic or seismic refraction techniques which is less expensive.

The essence (جوهر) of the seismic reflection technique is to measure the time taken for a seismic wave to travel from a source down into the ground where it is reflected back to the surface and then detected at a receiver.

The time is known as the **two way travel time (T.W.T.T).**

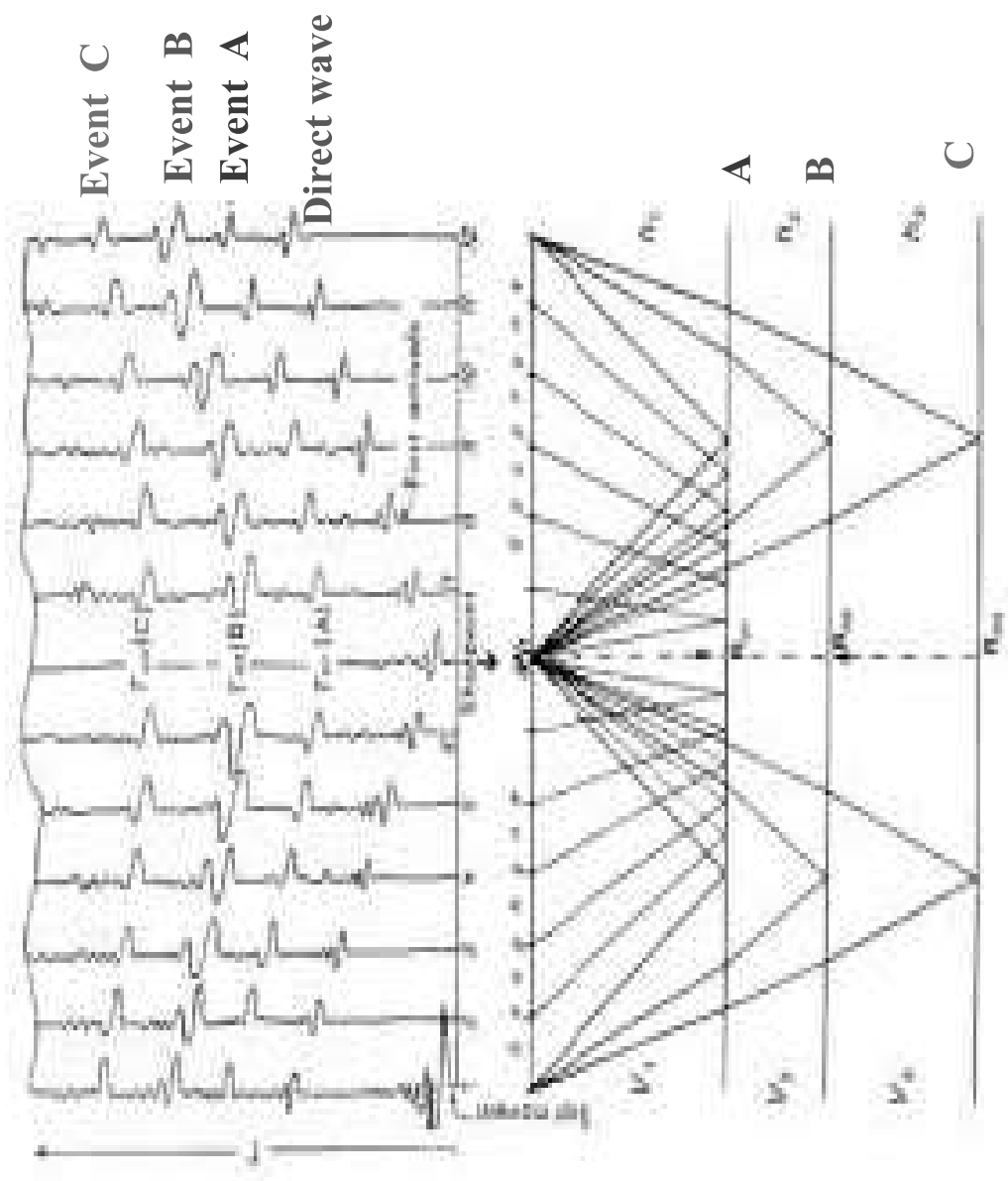

Event C

Event B

Event A

Direct wave

A

B

C

The most important problem in seismic reflection surveying is the **translation of (T.W.T.T) to depth.**

... While travel times are measured, the one parameter, that most affects the conversion of to depth is **seismic velocity.**

In reflection survey , the geophone separation is small compared to the depth.

Two unknowns (depth + velocity) ????

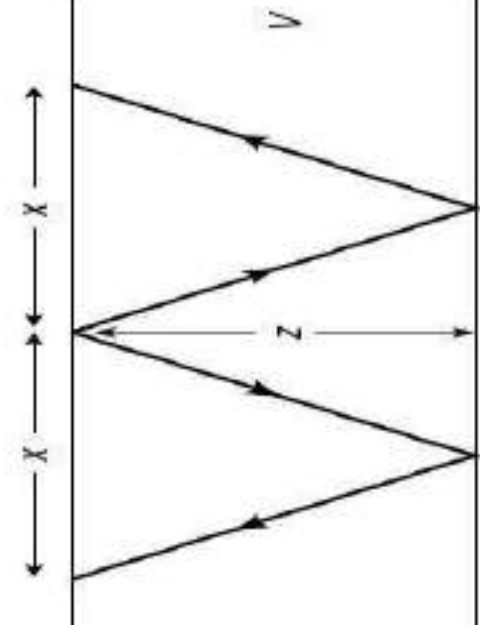

Reflection and transmission of normally incident seismic rays

Consider a compressional ray (P- wave) of amplitude A_0 normally incident on an interface between two media of differing velocity and density. A transmitted ray of amplitude A_2 travels on through the interface in the same direction as the incident ray and a reflected ray of amplitude A_1 returns back along the path of the incident ray.

The **total energy** of the transmitted and reflected rays must equal the **energy of the incident ray**.

The relative proportions of energy transmitted and reflected are determined by the contrast in **acoustic impedance** (Z) across the interface.

The acoustic impedance of a rock is the product of its **density** (ρ) and its **wave velocity** (v); that is,

$$Z = \rho v$$

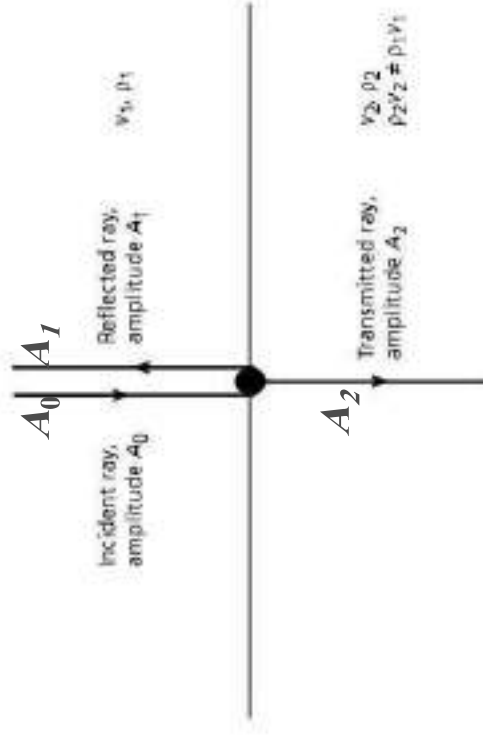

The **harder** a rock, the **higher** is its acoustic impedance, while the **smaller** the contrast in acoustic impedance across a rock interface the **greater** is the **proportion of energy transmitted through the interface**.

The *reflection coefficient* (R) is a numerical measure of the effect of an interface on wave propagation, and is calculated as the ratio of the **amplitude A_1 of the reflected ray to the amplitude A_0 of the incident ray**.

$$R = A_1 / A_0$$

$$R = \frac{\rho_2 v_2 - \rho_1 v_1}{\rho_2 v_2 + \rho_1 v_1} = \frac{Z_2 - Z_1}{Z_2 + Z_1}$$

From this equation it follows that $-1 \leq R \leq +1$.

The **transmission coefficient** T is the ratio of the amplitude A_2 of the transmitted ray to the amplitude A_0 of the incident ray

$$T = A_2 / A_0 = \frac{2Z_1}{Z_2 + Z_1}$$

Reflection and transmission coefficients are some times expressed in terms of energy rather than wave amplitude

If $R = 0$, ...all the incident energy transmitted. This is the case when there is no contrast of acoustic impedance across the interface, even if the density and velocity values are different in the two layers (i.e. $Z_1 = Z_2$).

.... If $R = +1$ or -1 , ... all the incident energy is reflected.

$R = 0$; All the incident energy transmitted, ($Z_1 = Z_2$) no reflection.
 $R = +1$ or -1 , all the incident energy is reflected, (Strong reflection).

Q / When the R will be (+ve) or (-ve) and how is it noticed on the seismogram ? ? ? ?

Question: A P-wave of amplitude 1.0 is produced by an earthquake at the Earth's surface and travels vertically downward where it encounters the Moho (boundary between crust and mantle). What is the amplitude of the P-waves that are reflected and transmitted at the Moho?

Assume: $v_c = 5000$ m/s, $\rho_c = 2850$ kg/m³, $v_m = 8000$ m/s, $\rho_m = 3250$ kg/m³

v_c = velocity in the crust ,
 ρ_c = density of the crust,

v_m = velocity in the mantle
 ρ_m = density of the mantle

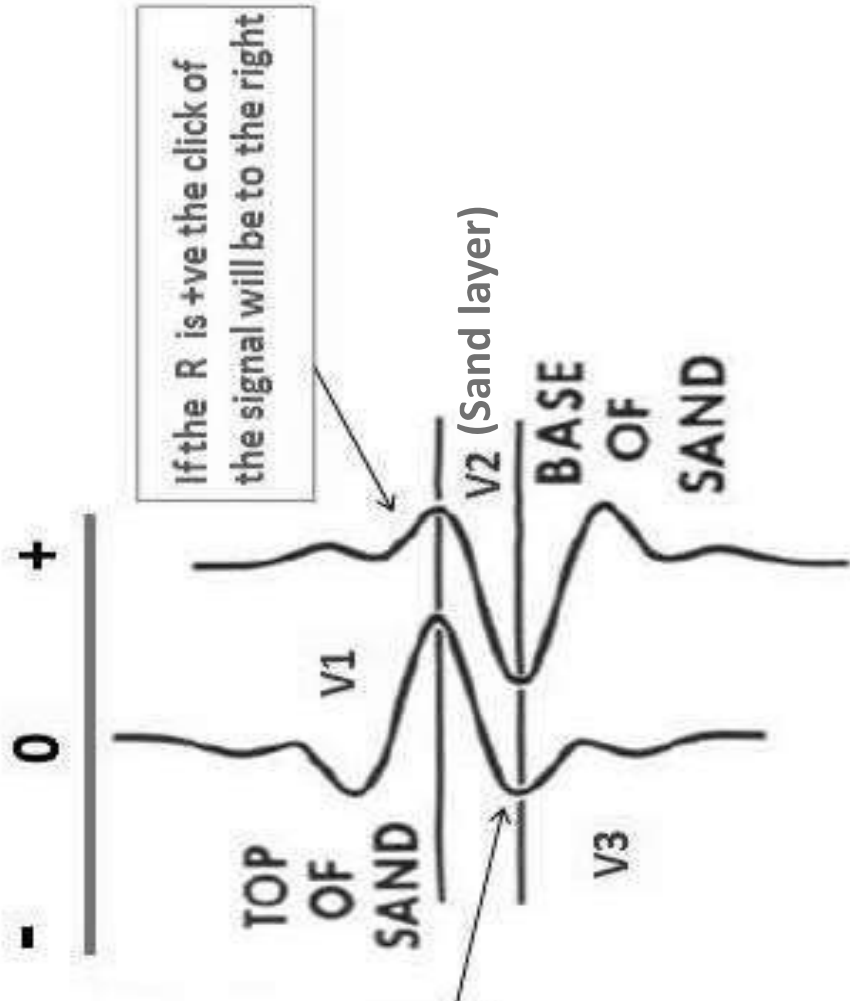

If the R is +ve the click of the signal will be to the right

If the R is -ve the click of the signal will be to the left

$$V2 > V1$$

V1 may be equal to V3

Reflection Coefficients

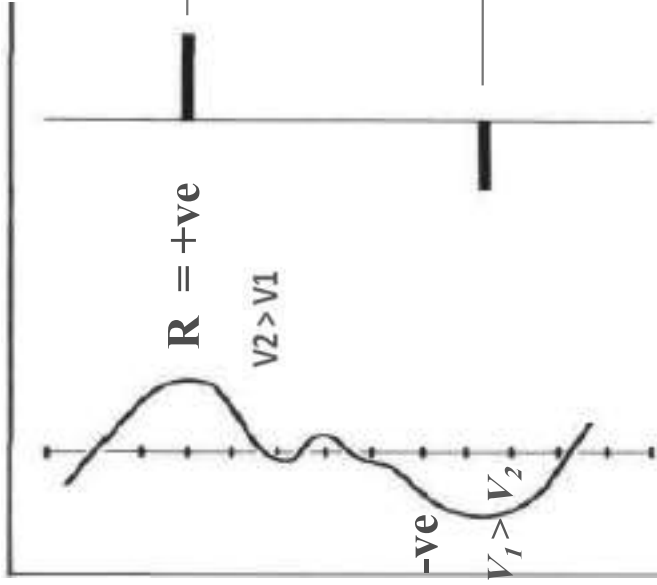
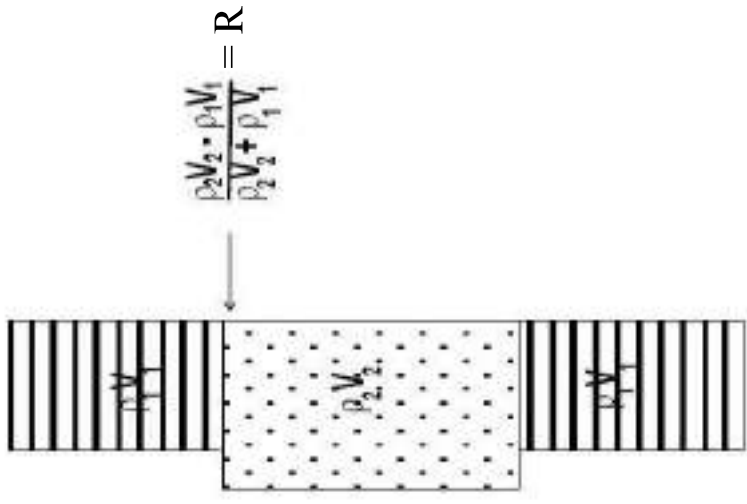

VERTICAL SEISMIC TRACE THROUGH RESERVOIR

TRACKED AMPLITUDES FROM TOP AND BASE REFLECTIONS

Where there is a change in ρV , some of the incident acoustic energy will be reflected at the interface and some will be transmitted

Geometry of reflected wave path

1- Horizontal Reflector:-

The travel time from (S) to (G) calculated by using image point, the image of (S) is (I) at depth (h) below the reflector.

Travel time of direct wave = $T_D = X / V$

...Suppose the travel time of reflected

wave from (S) to (G) is (t_{refl}).

$t_{refl} = \text{Distance} / \text{Velocity}$

Distance = $SC + CG = IG$ due to $SC = IC$

From Triangle SGI $(IG)^2 = X^2 + (2h)^2$

$IG = t * V$; it is the time at a certain geophone

$(tV)^2 = X^2 + (2h)^2$ Divide by $4h^2$

$$\frac{t^2 V^2}{4h^2} - \frac{x^2}{4h^2} = 1$$

Hyperbola Equation

Depth of the reflector is obtained by plotting $x = 0$, t will be t_0

Therefore $\frac{t_0^2 V^2}{4h^2} = 1$ and $h = 1/2 t_0 V$

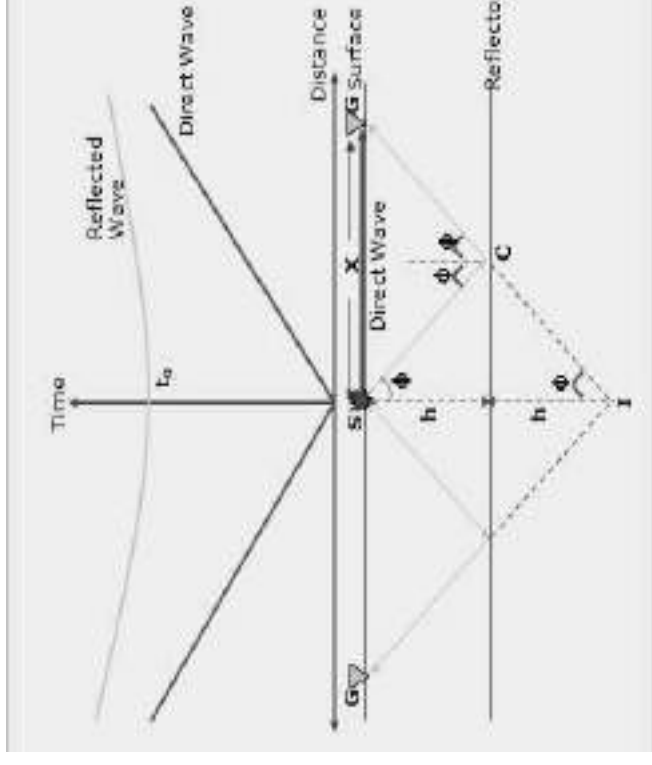

From Triangle SGI

$$(IG)^2 = X^2 + (2h)^2$$

$$IG = SC = tV = \sqrt{(2h)^2 + x^2}$$

If 2 outside the bracket;

$$t * v = 2 \sqrt{(h^2 + (x/2)^2)}$$

$$t^2 * V^2 = 4 (h^2 + (x^2/4)) \dots\dots (1)$$

$$t^2 * V^2 = 4 h^2 + x^2 \dots\dots (2) ; \text{ therefore :-}$$

$$h = \frac{1}{2} \sqrt{(t^2 V^2 - x^2)} \dots\dots (t) \text{ is a time at a distance } (x)$$

$$h = \frac{1}{2} t_0 V \dots\dots \text{ when } X=0$$

From equation (2) $t^2 = 4 / V^2 (h^2 + (x^2/4))$ by opening the bracket

$$t^2 = 4 x^2 / 4 V^2 + 4 h^2 / V^2$$

$$\text{Since } t_0 = 2h / v ; t^2 = x^2 / V^2 + t_0 \dots\dots\dots (3)$$

$$t^2 - t_0^2 = x^2 / V^2$$

$$t - t_0 = x / V = \Delta t$$

$$\text{From equation (1) } t = 2 / V \sqrt{(h^2 + (x/2)^2)} \dots\dots (4)$$

$$\frac{V^2 t^2}{4h^2} - \frac{x^2}{4h^2} = 1$$

Hyperbola Equation ;

$$\text{When } X = 0 \quad \frac{t_0^2 V^2}{4h^2} = 1$$

we can find the depth of the reflector by plotting x^2 vs t^2

